

Grundlagen der Datenbanken

# Sukzessiver Aufbau eines B-Baums vom Grad $k=2$

Dr. Thomas Gottron  
Wintersemester 2012/13

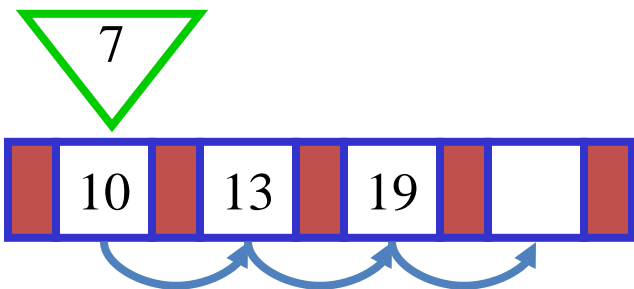

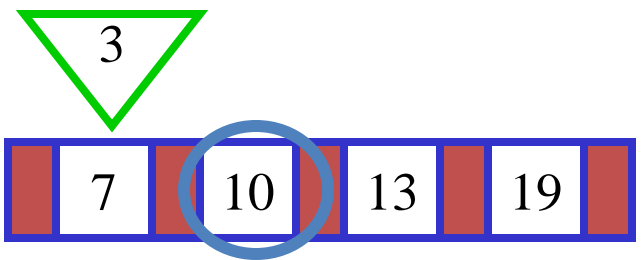

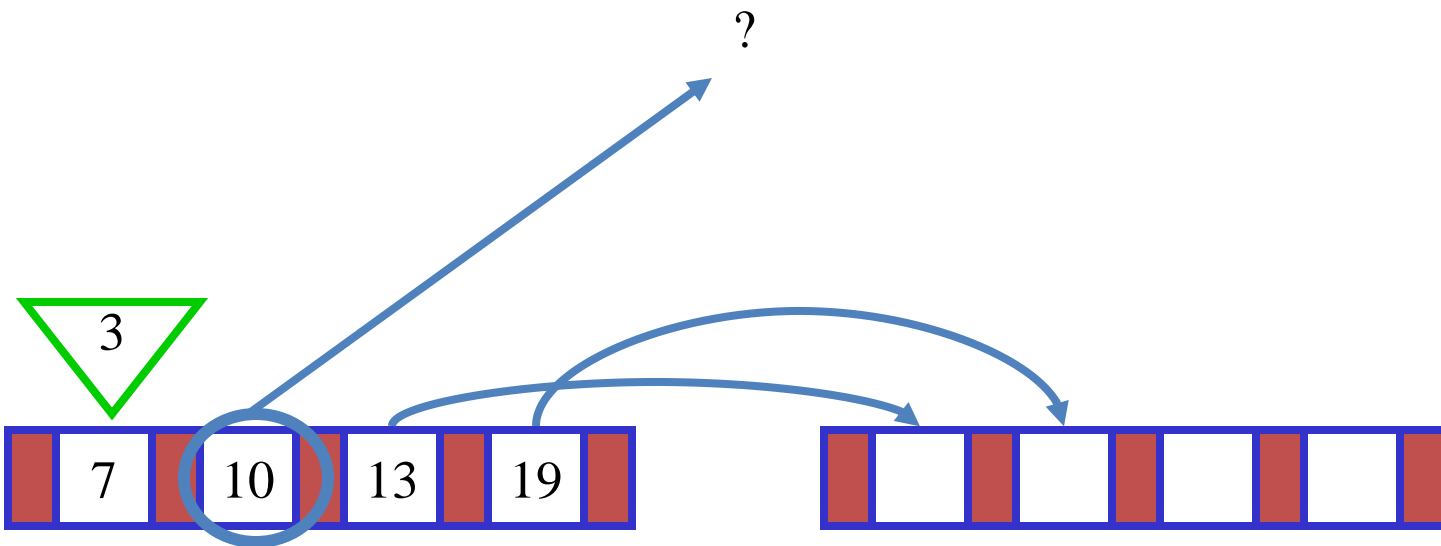

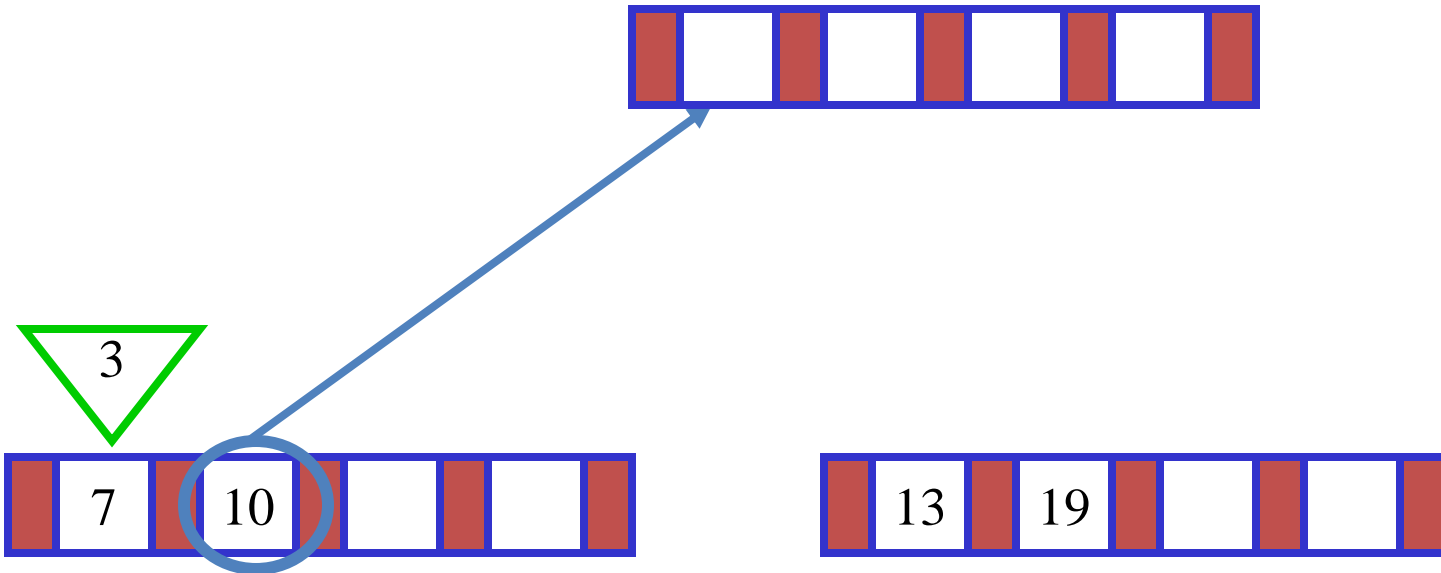

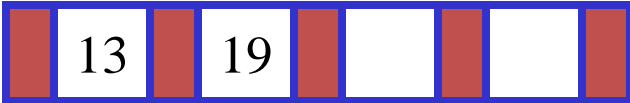
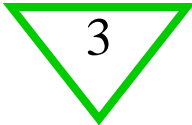

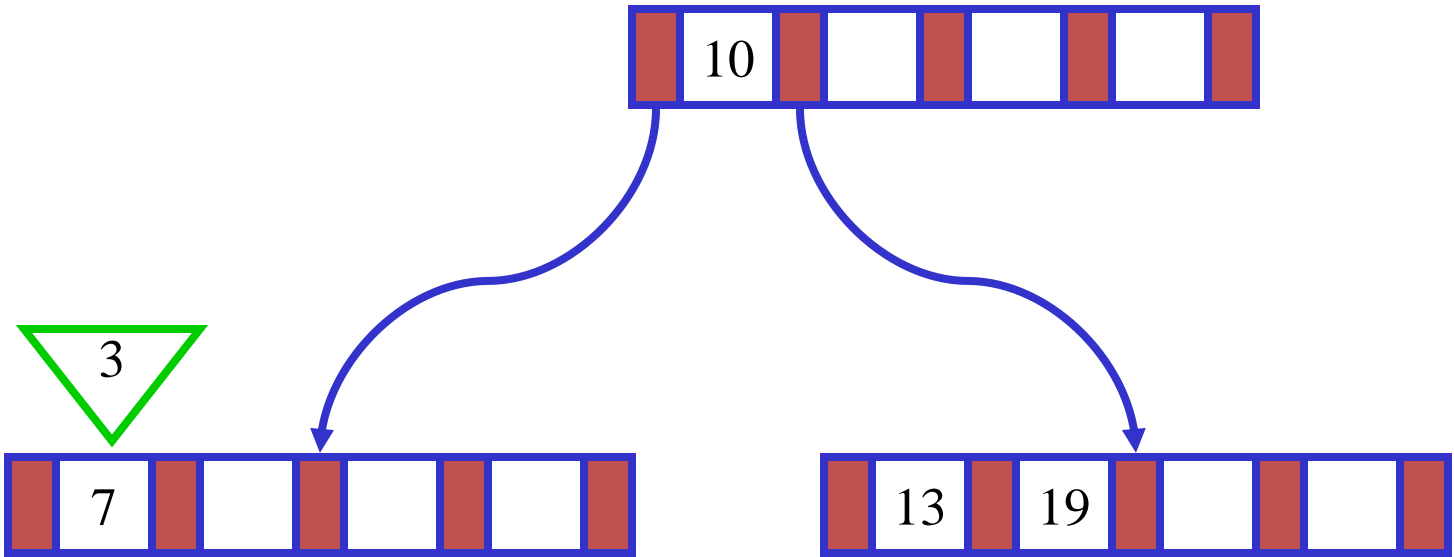

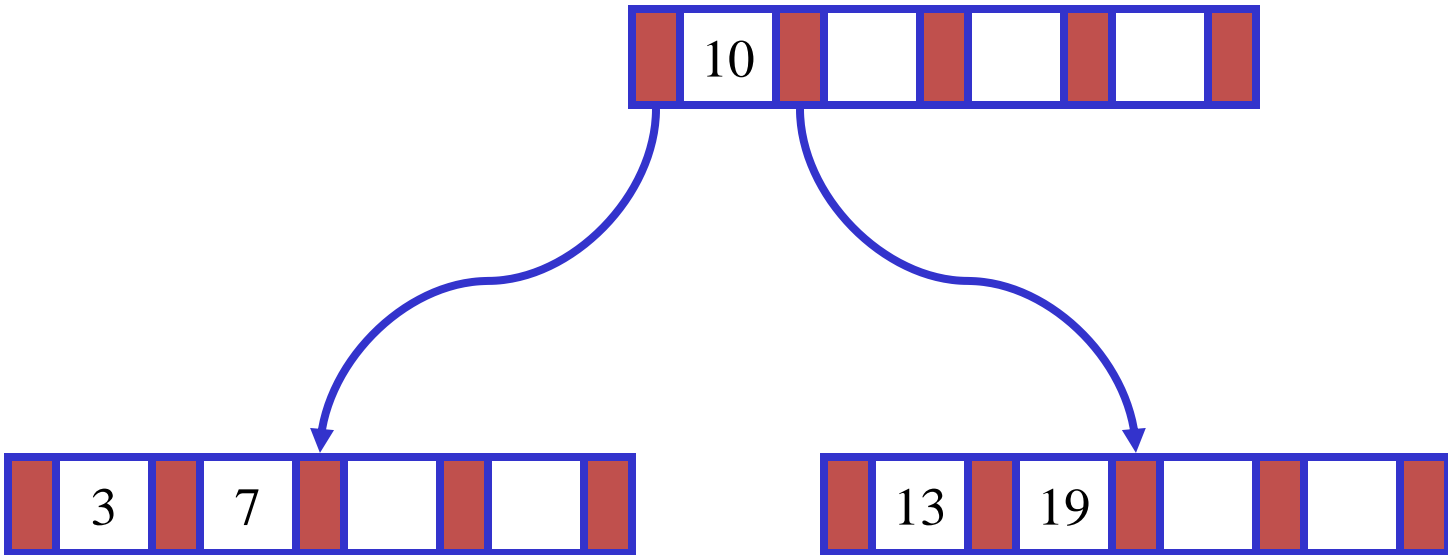



1

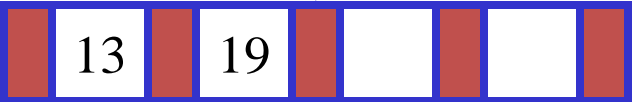
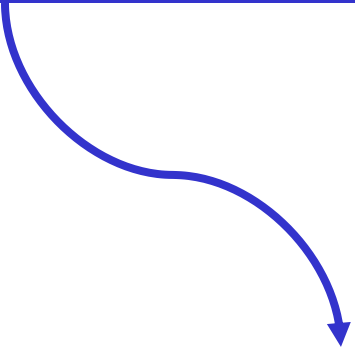
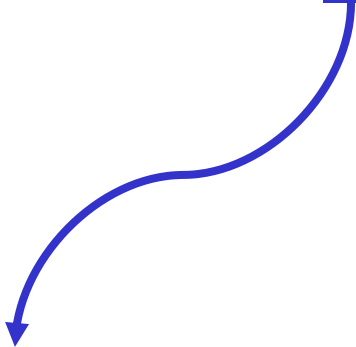

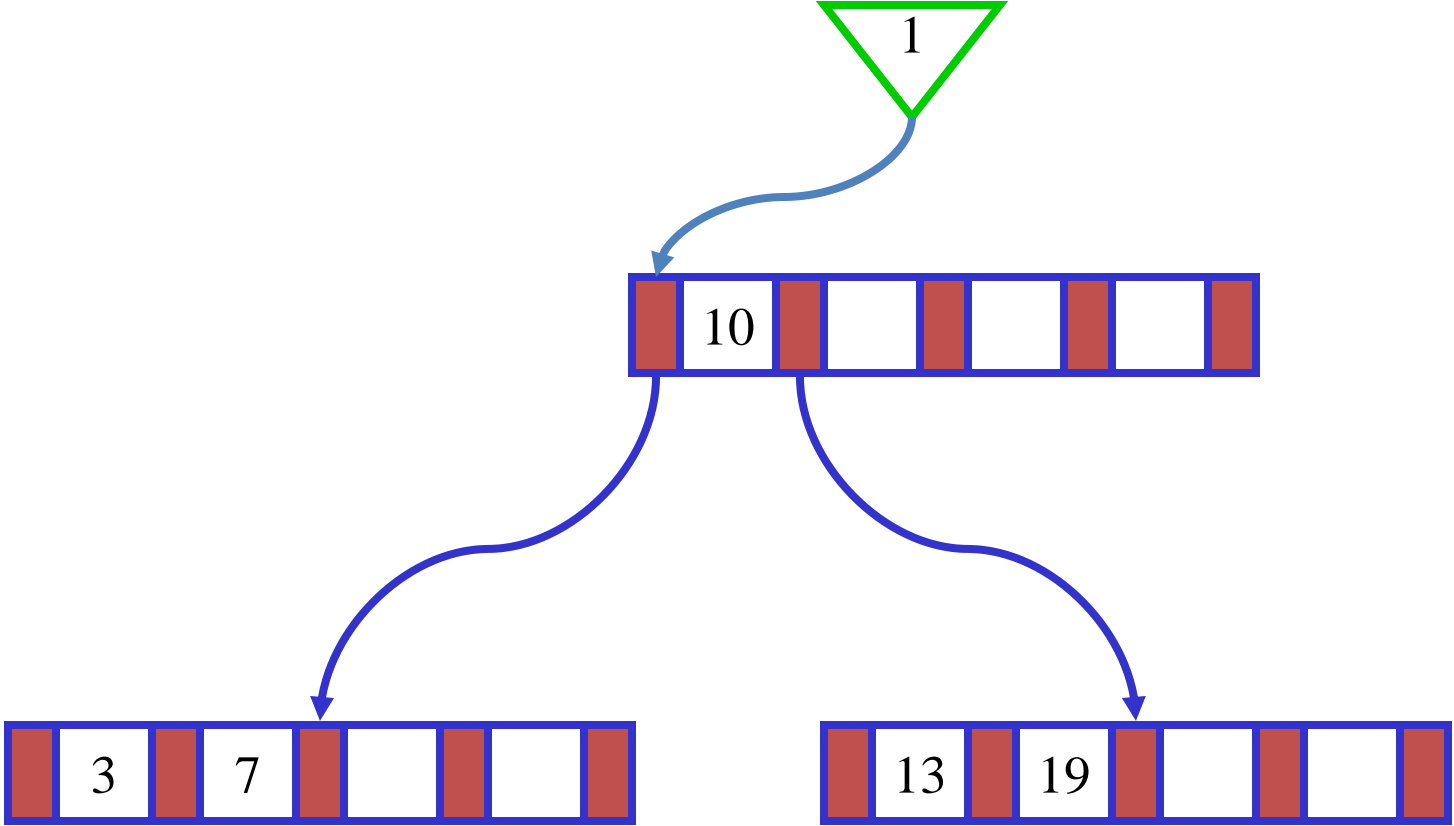

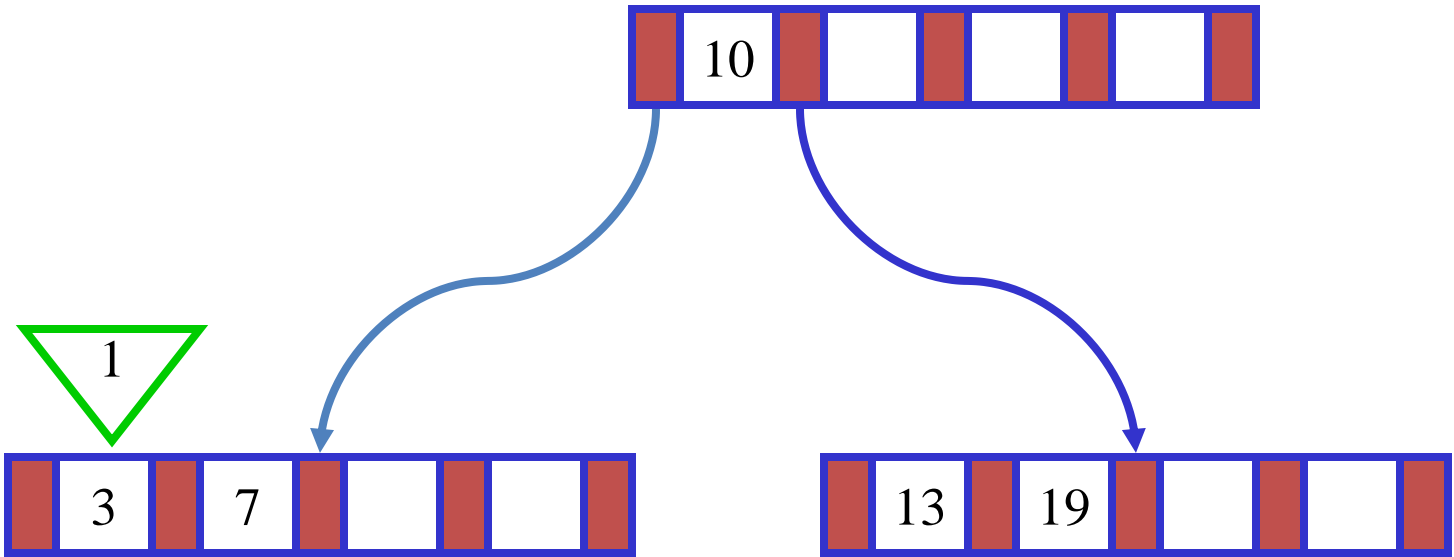

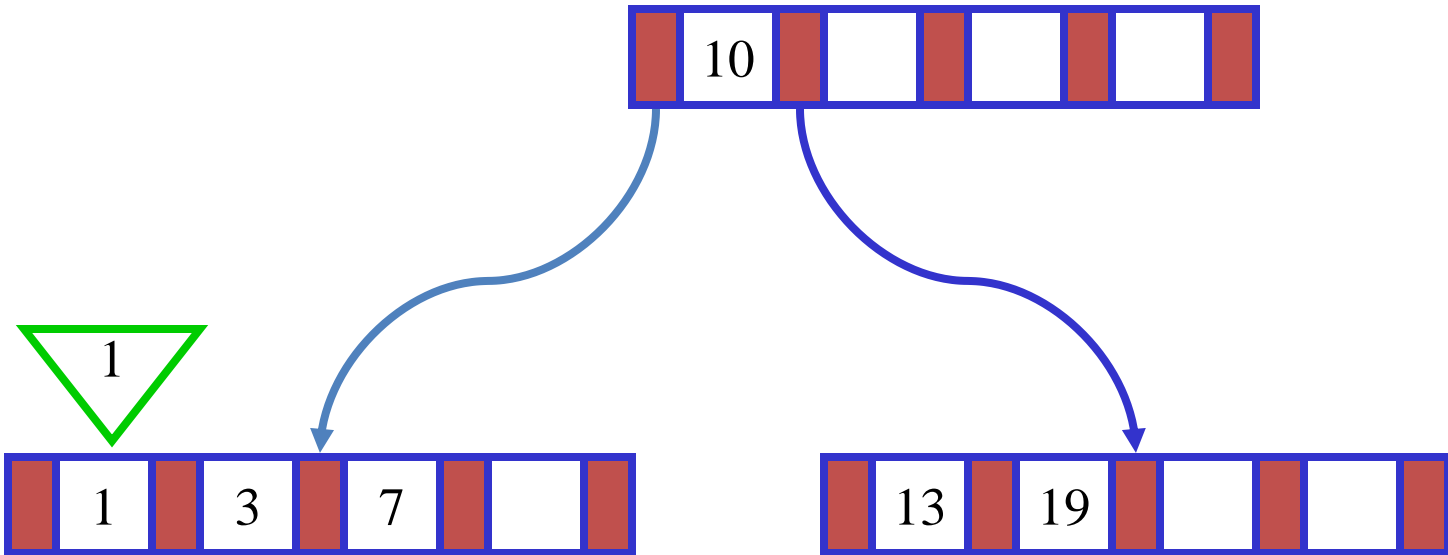

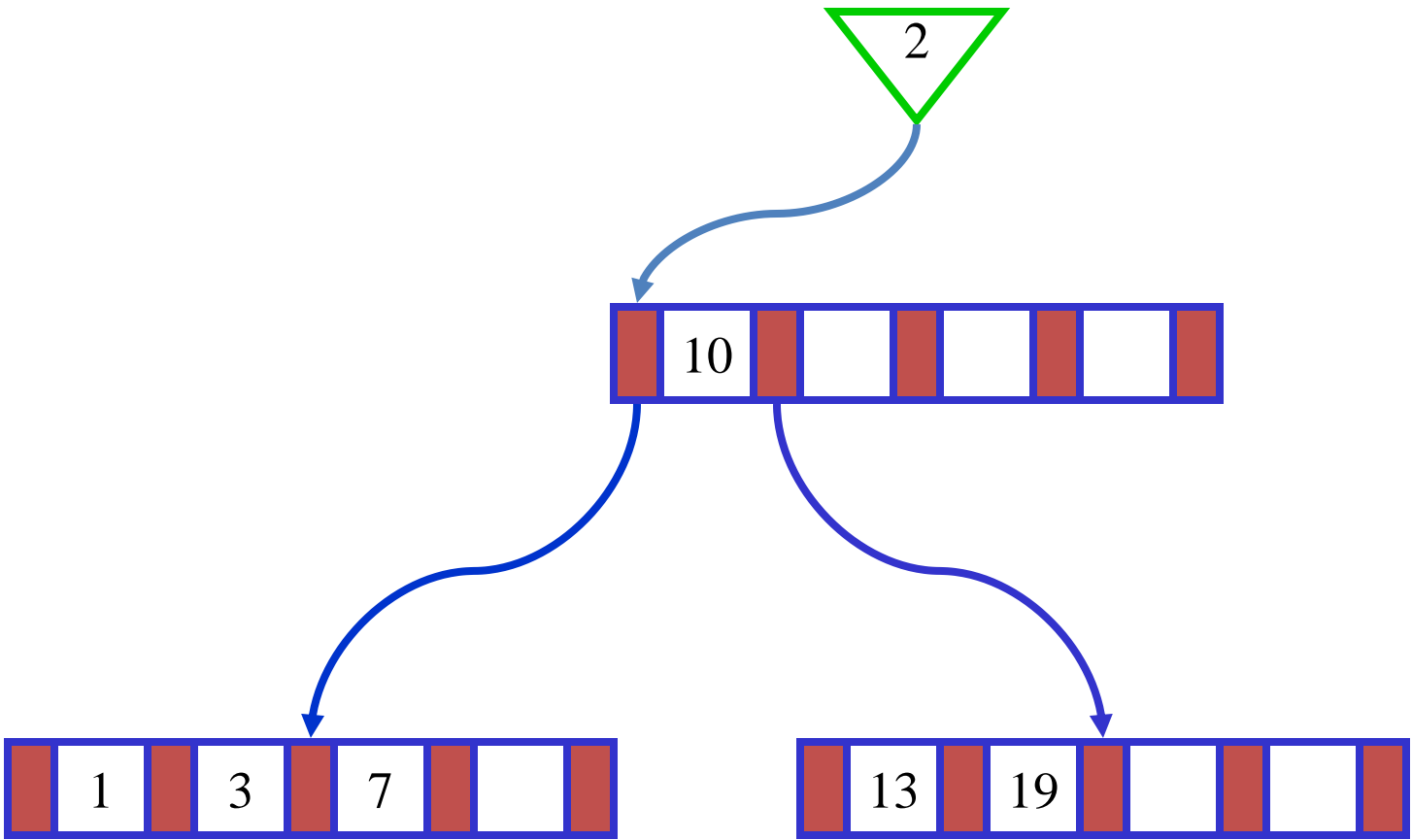

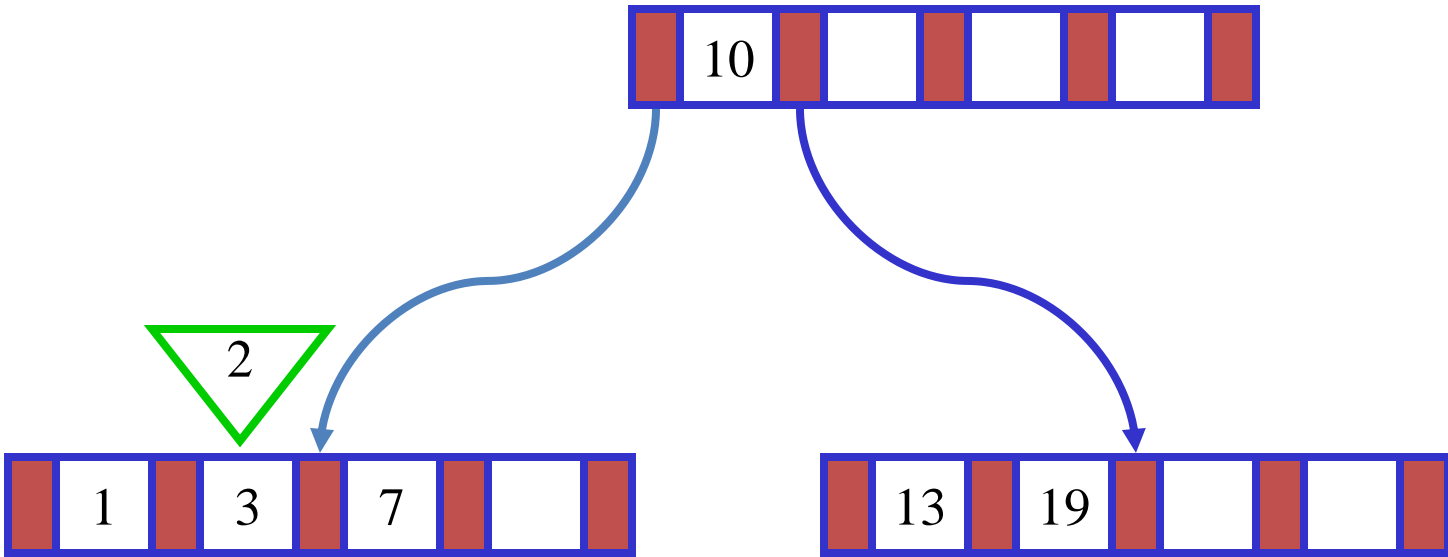

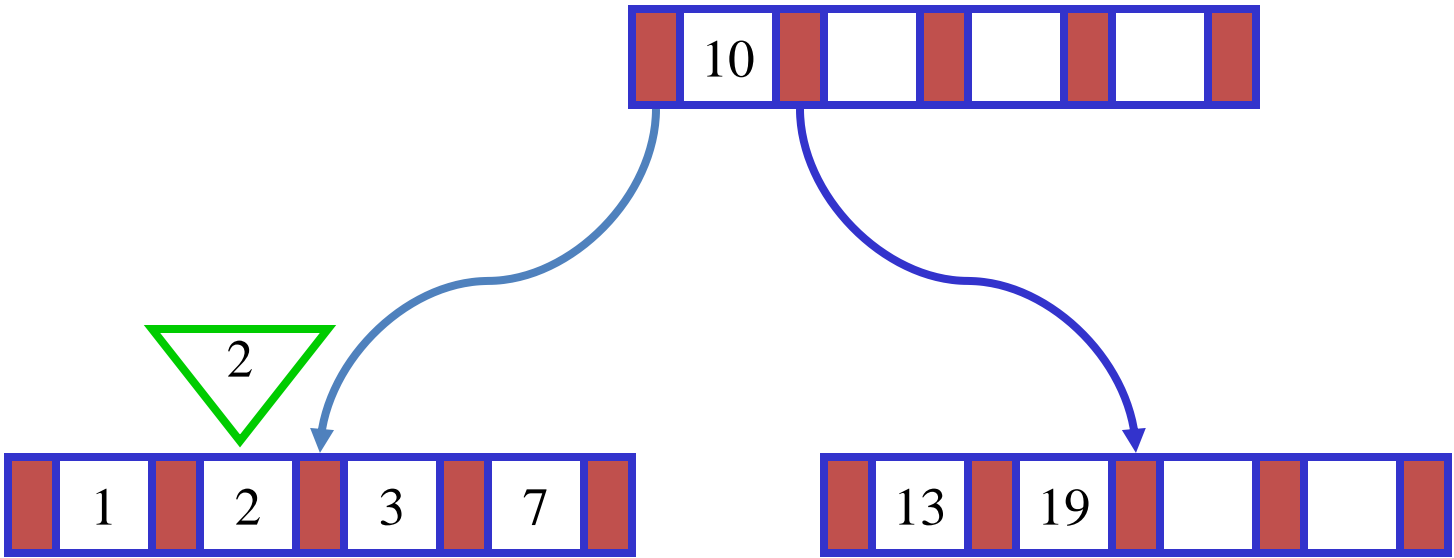

4

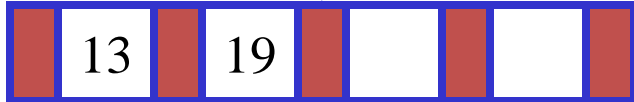
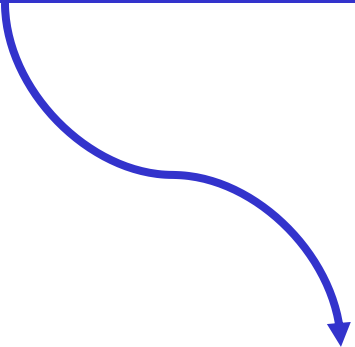
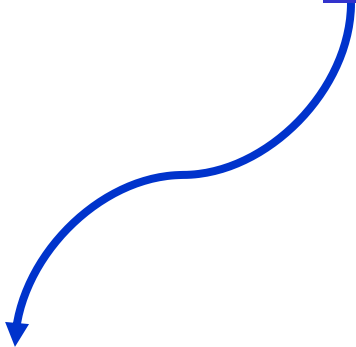



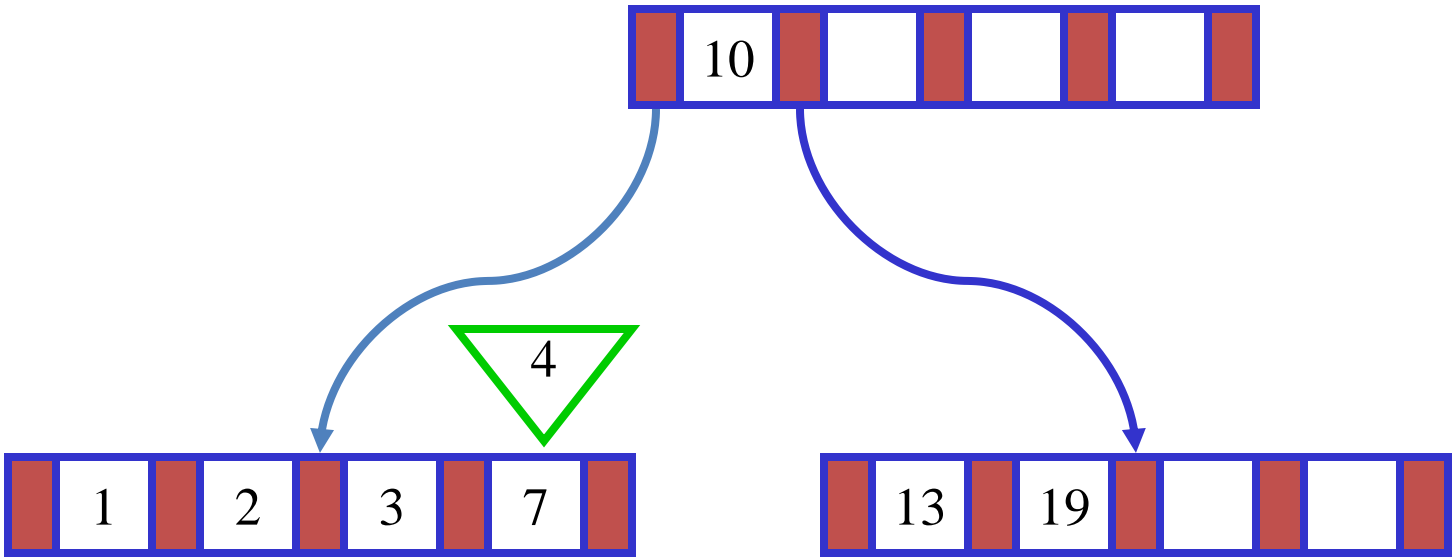

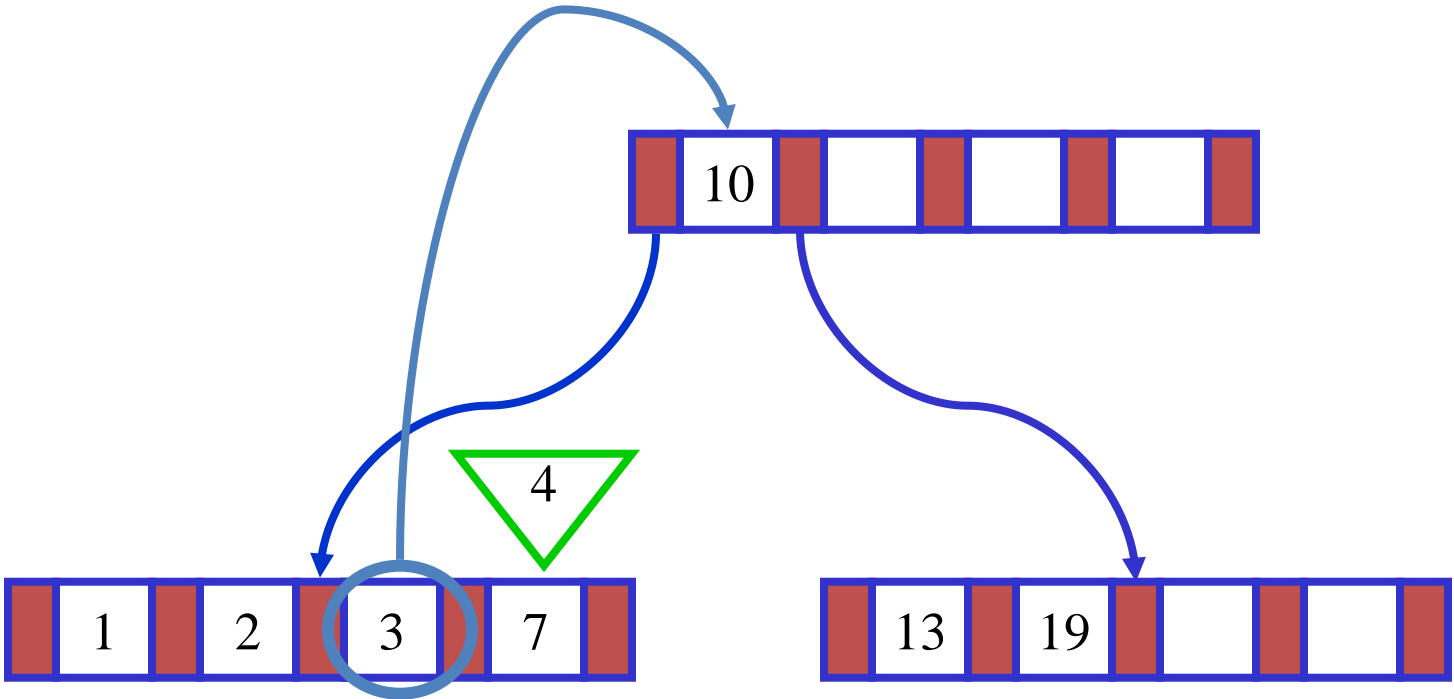

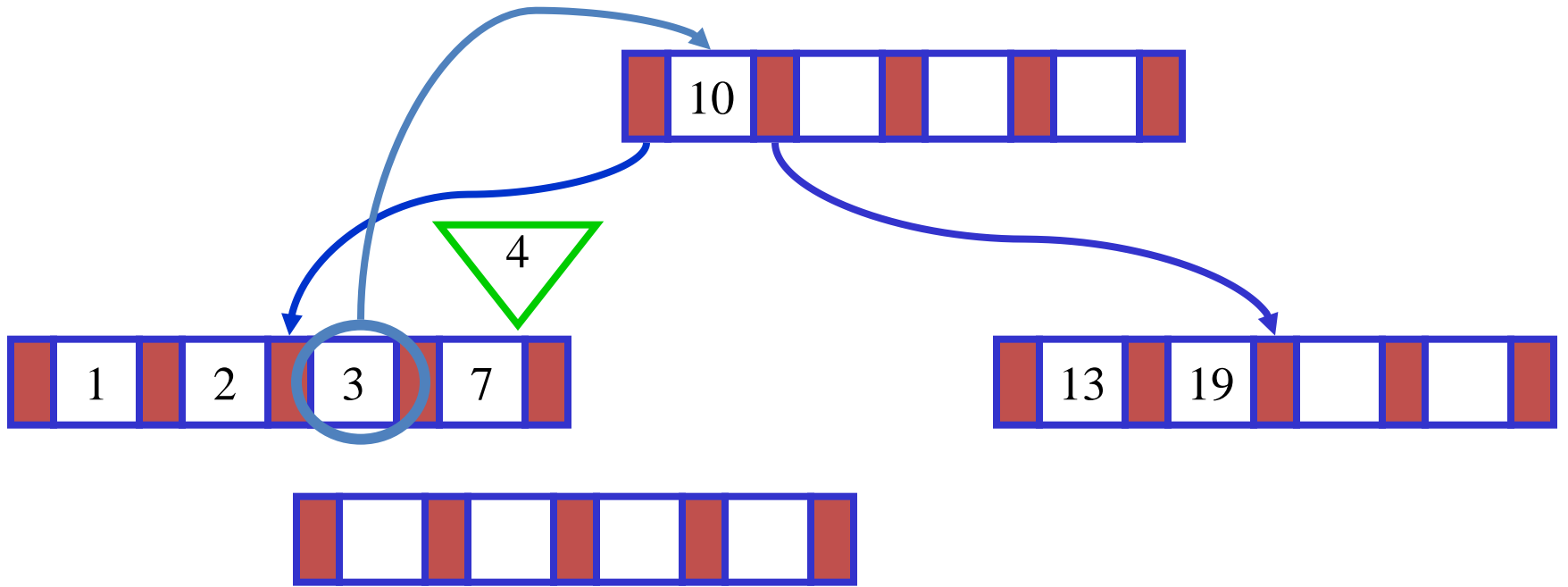

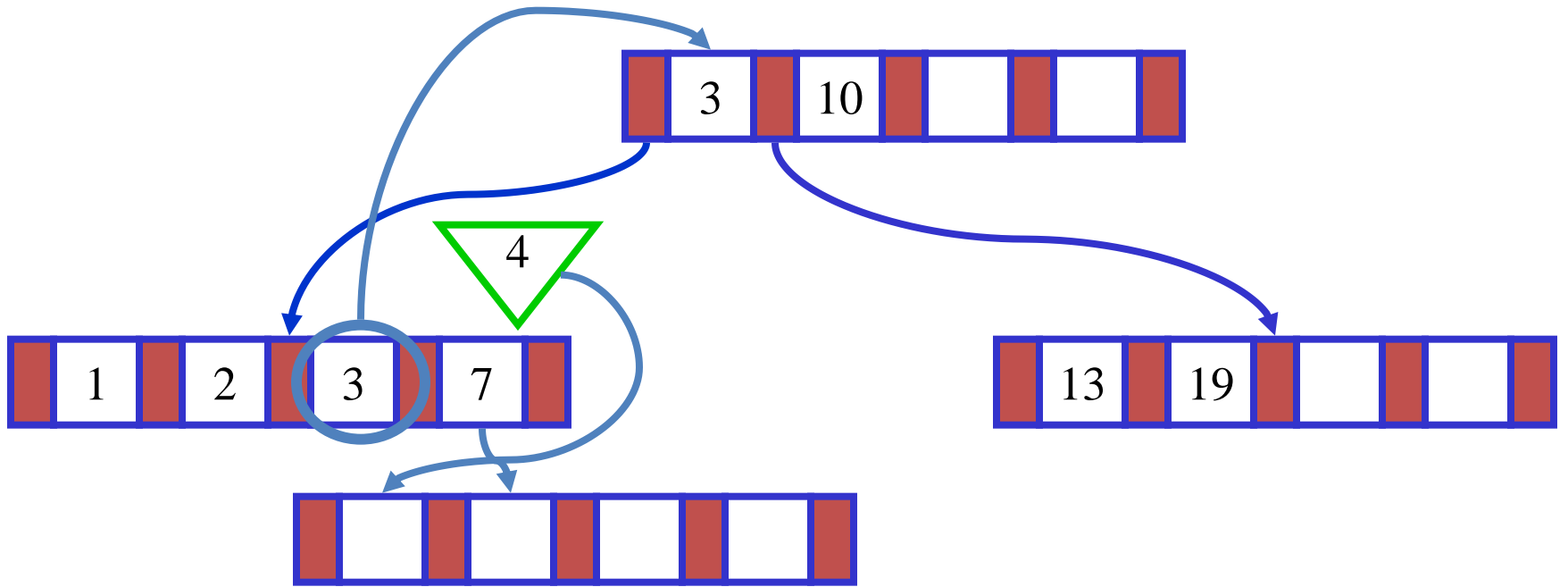

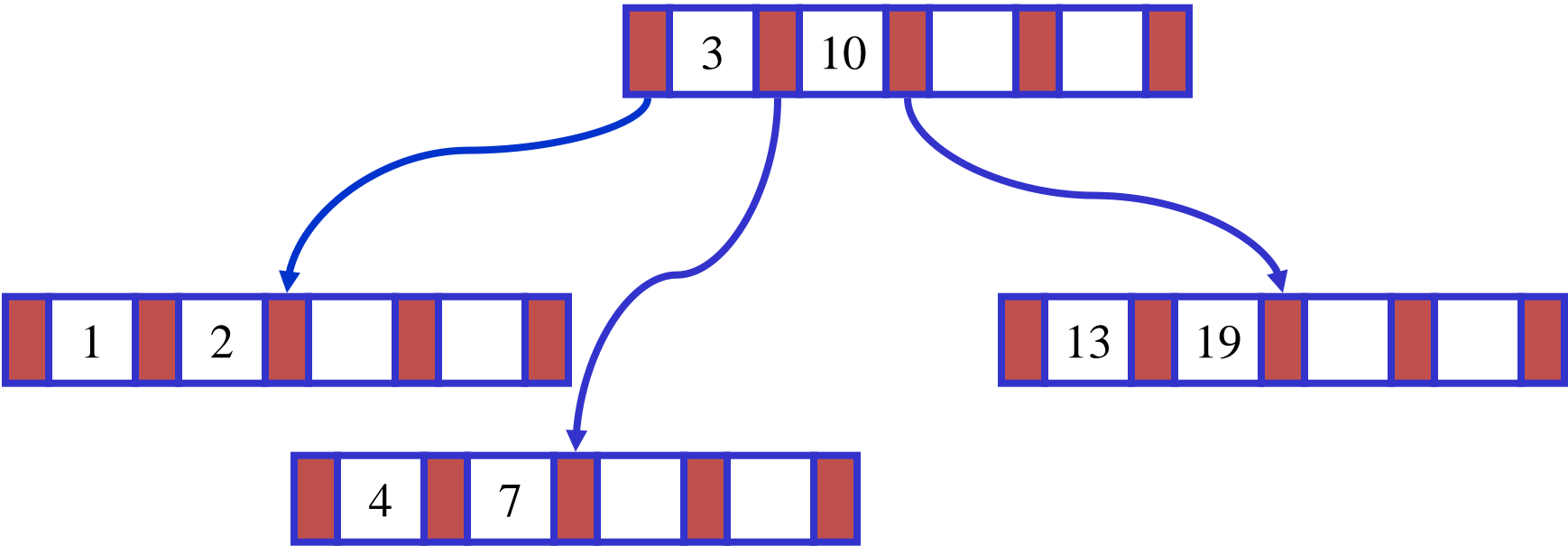

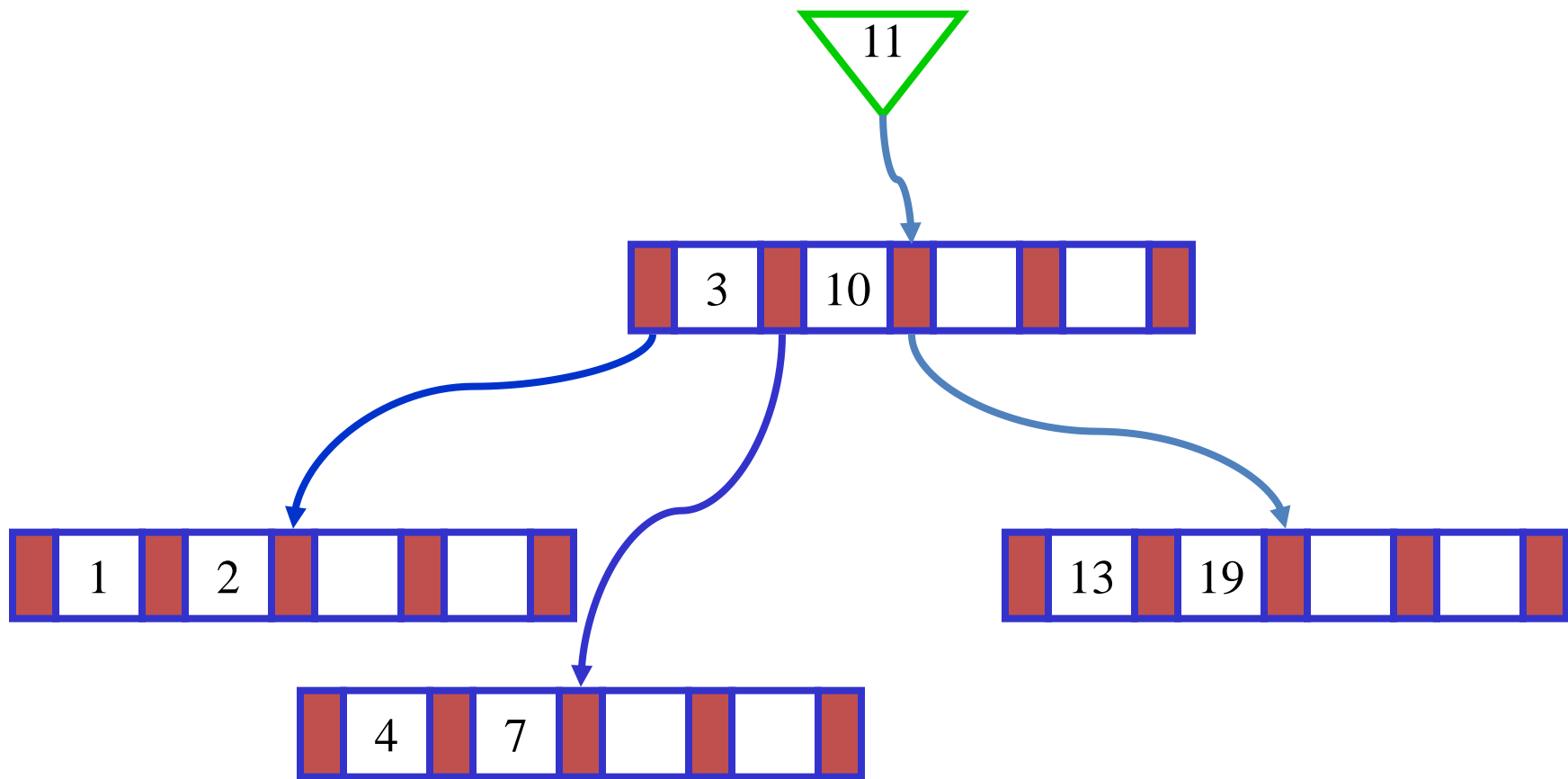

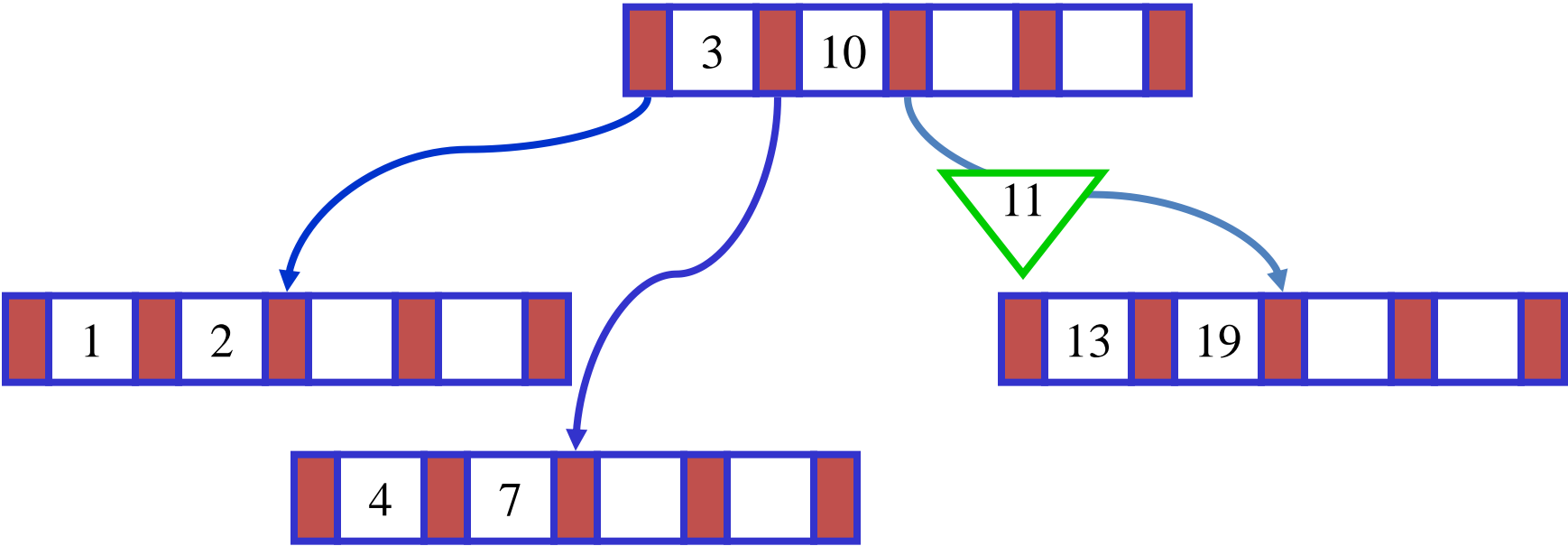

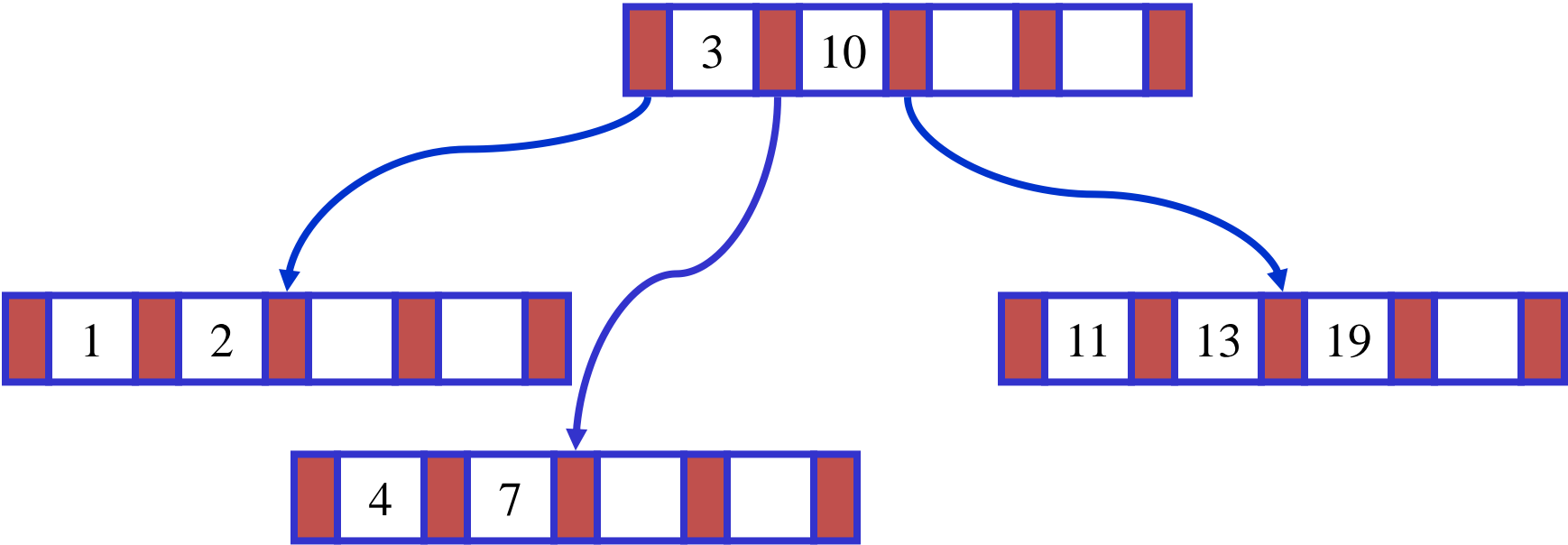



21

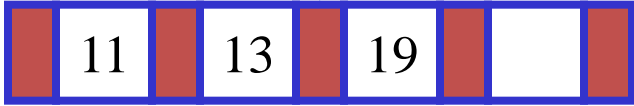
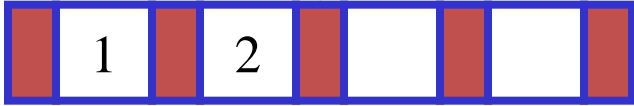
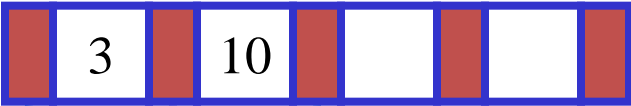

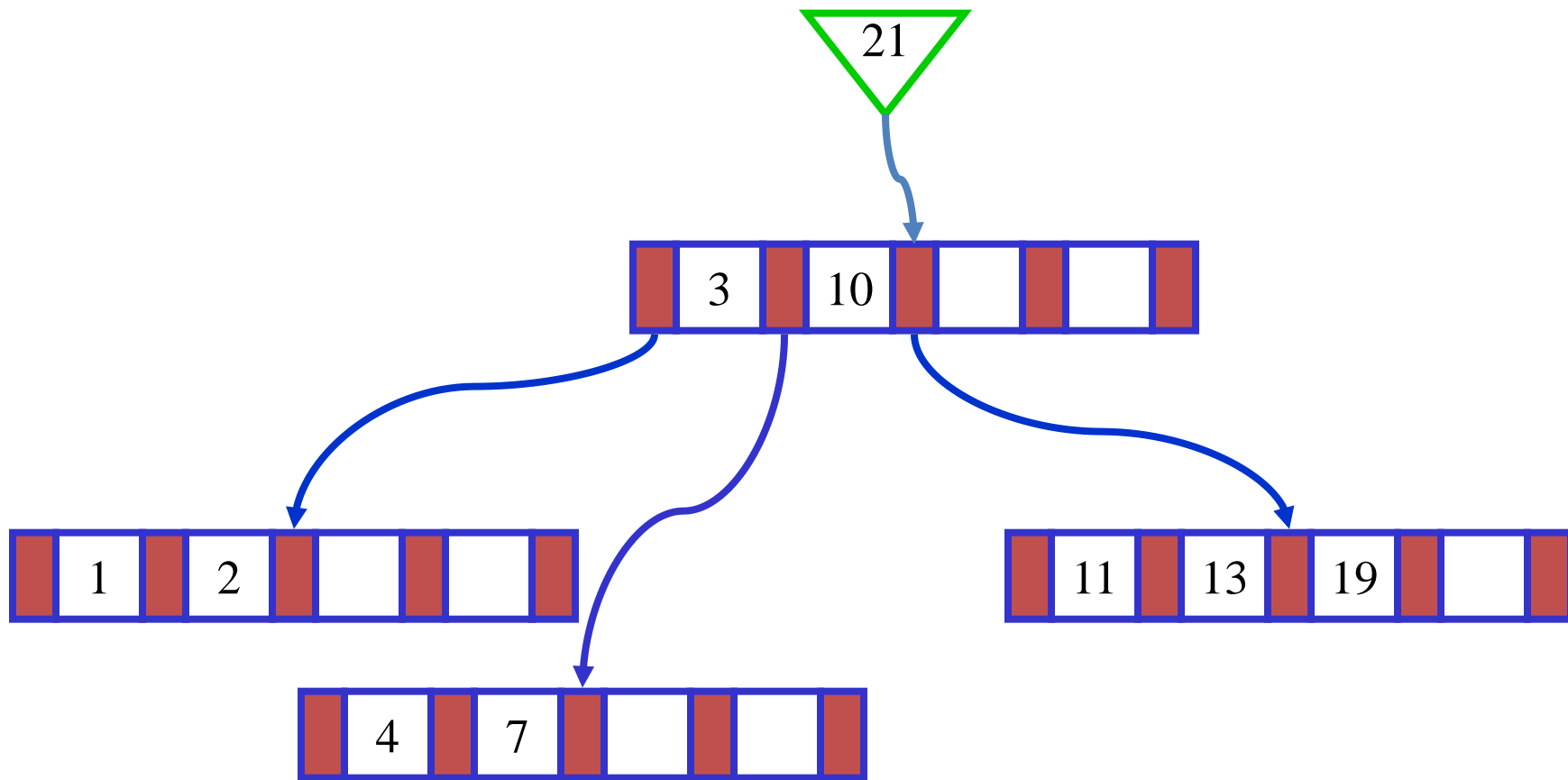

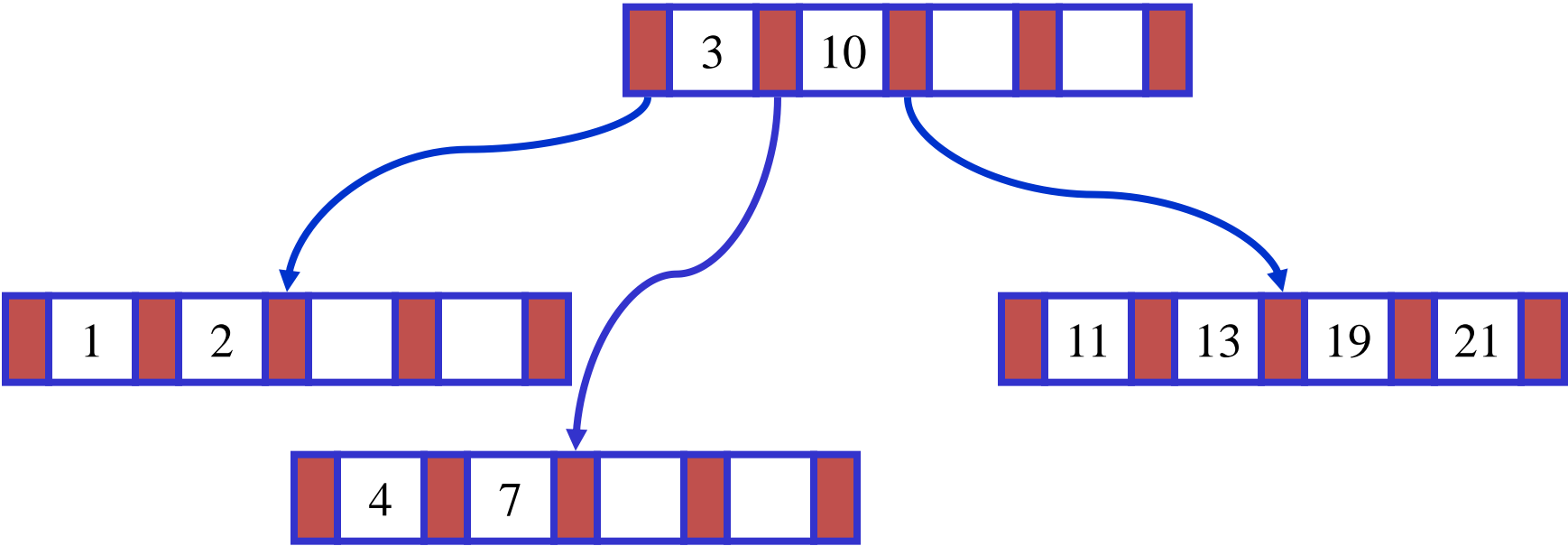

12

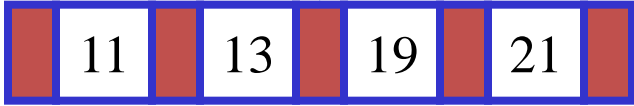
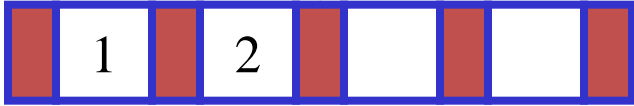
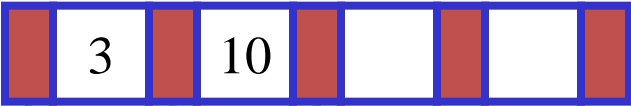

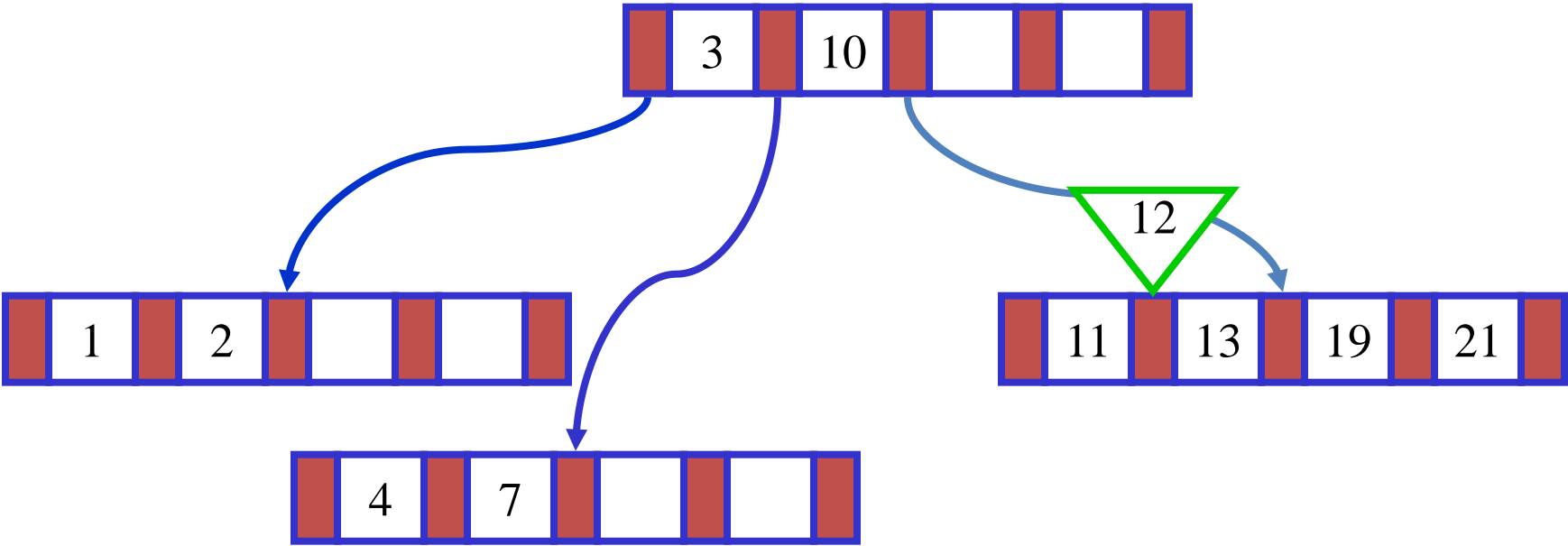

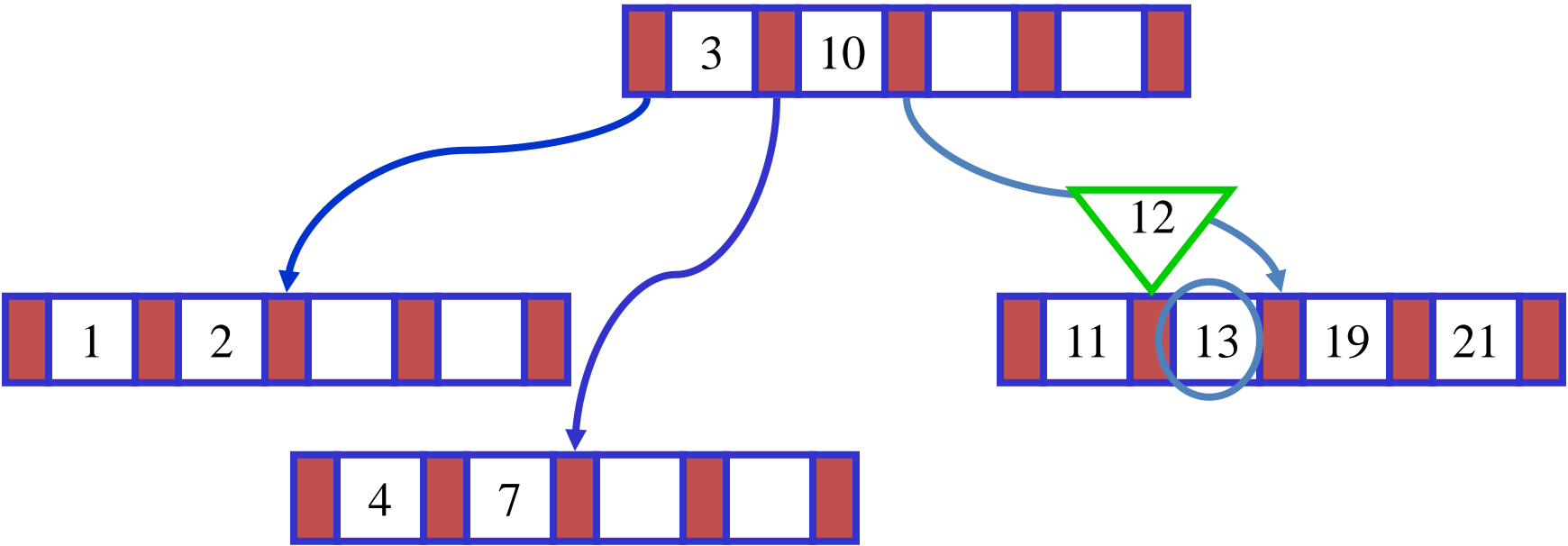

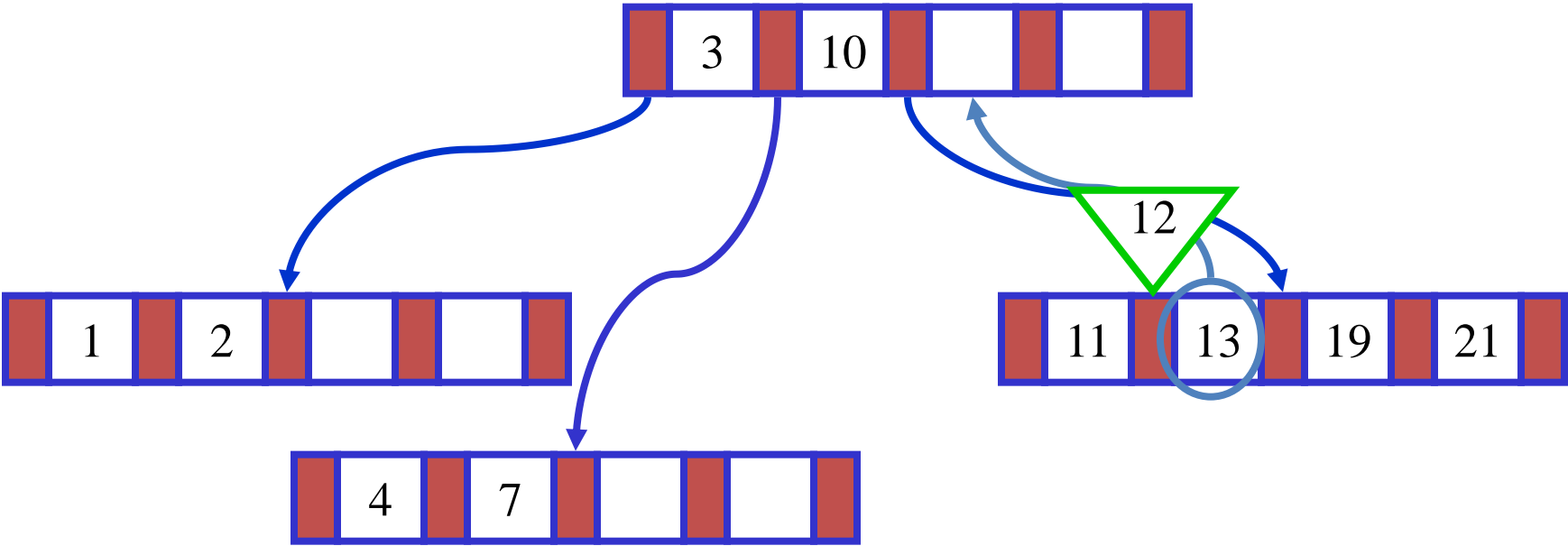

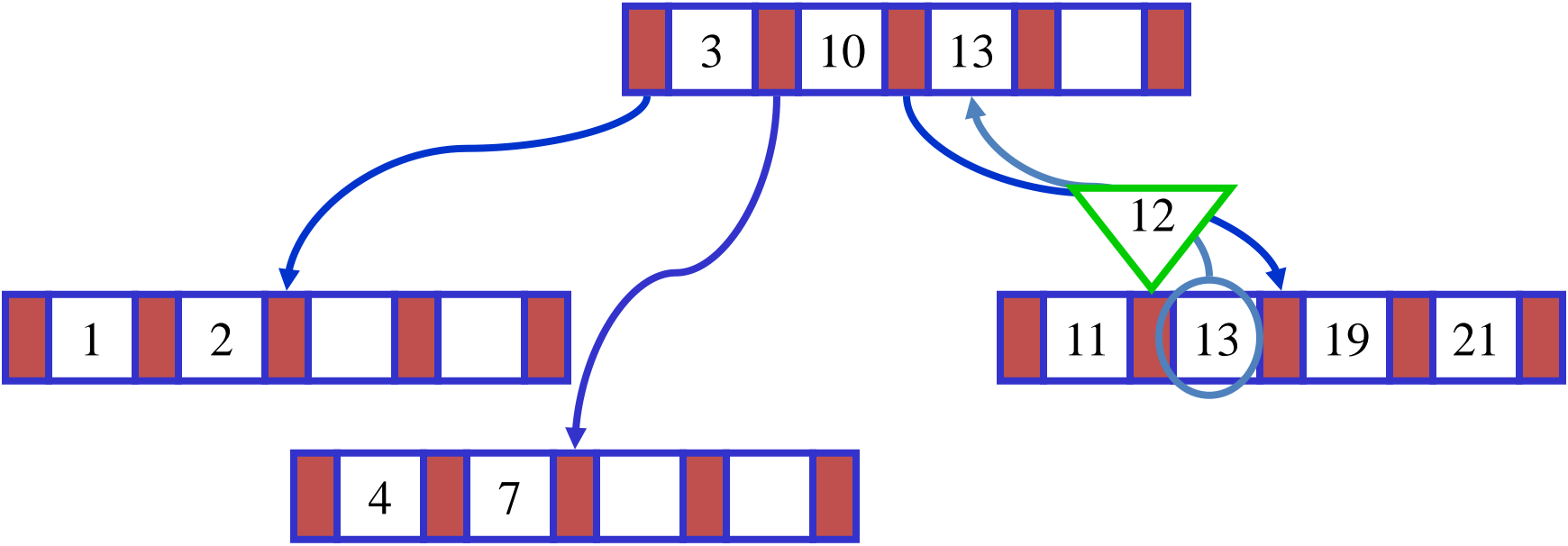



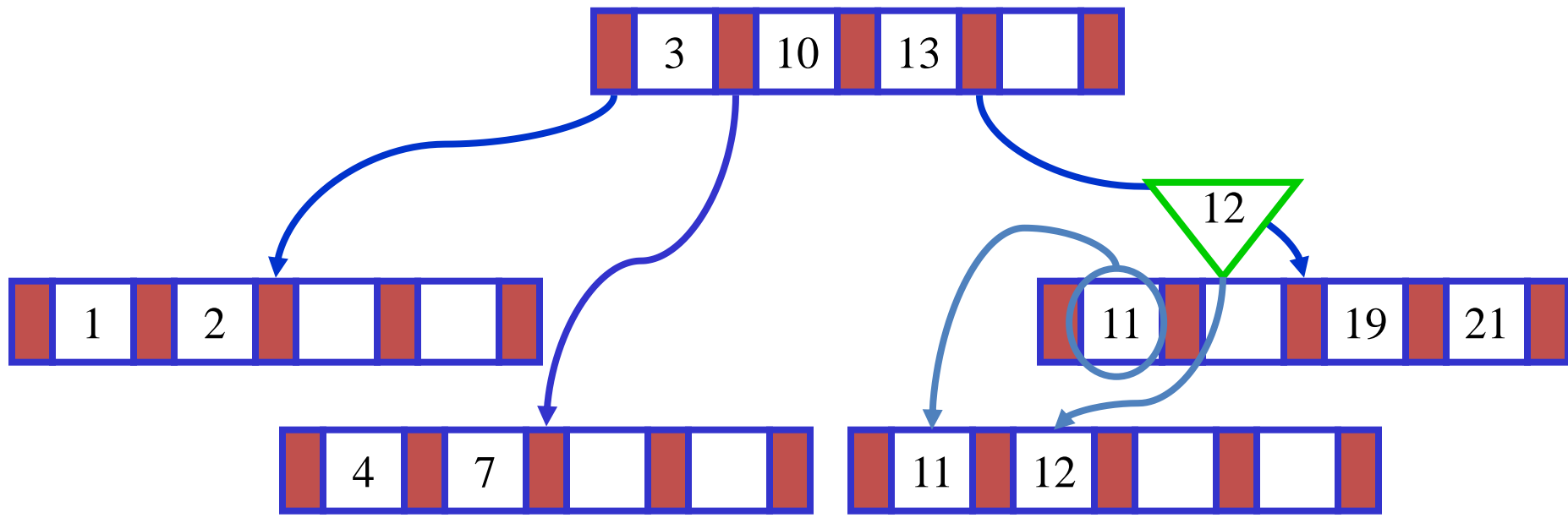

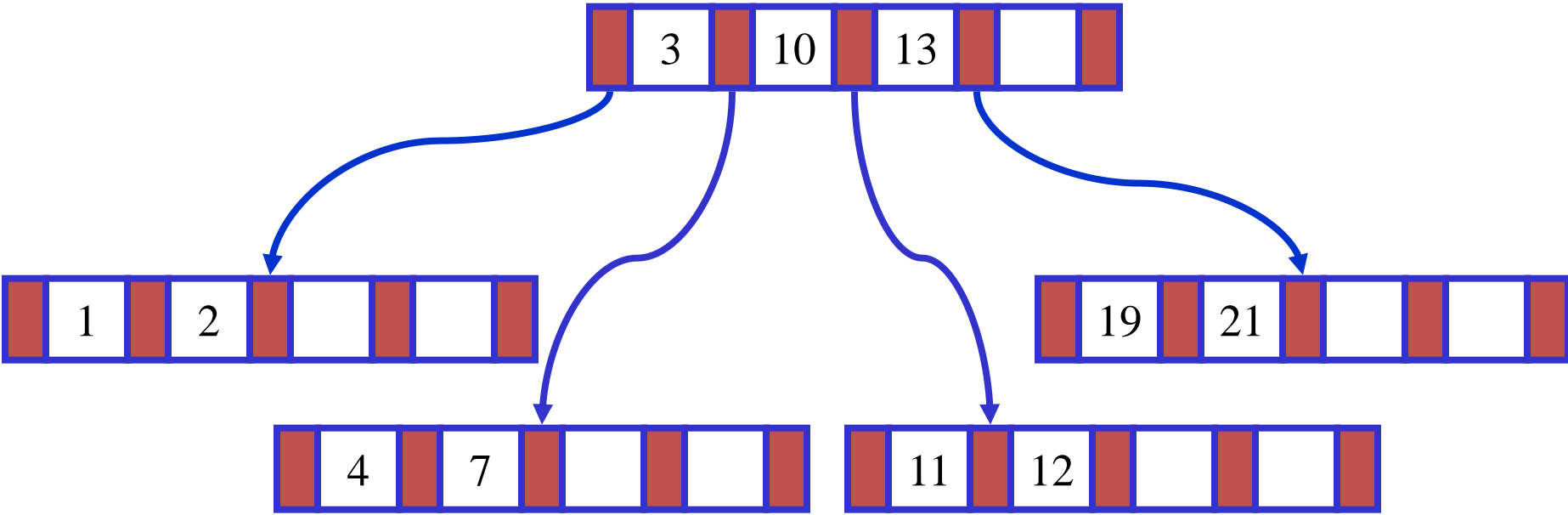

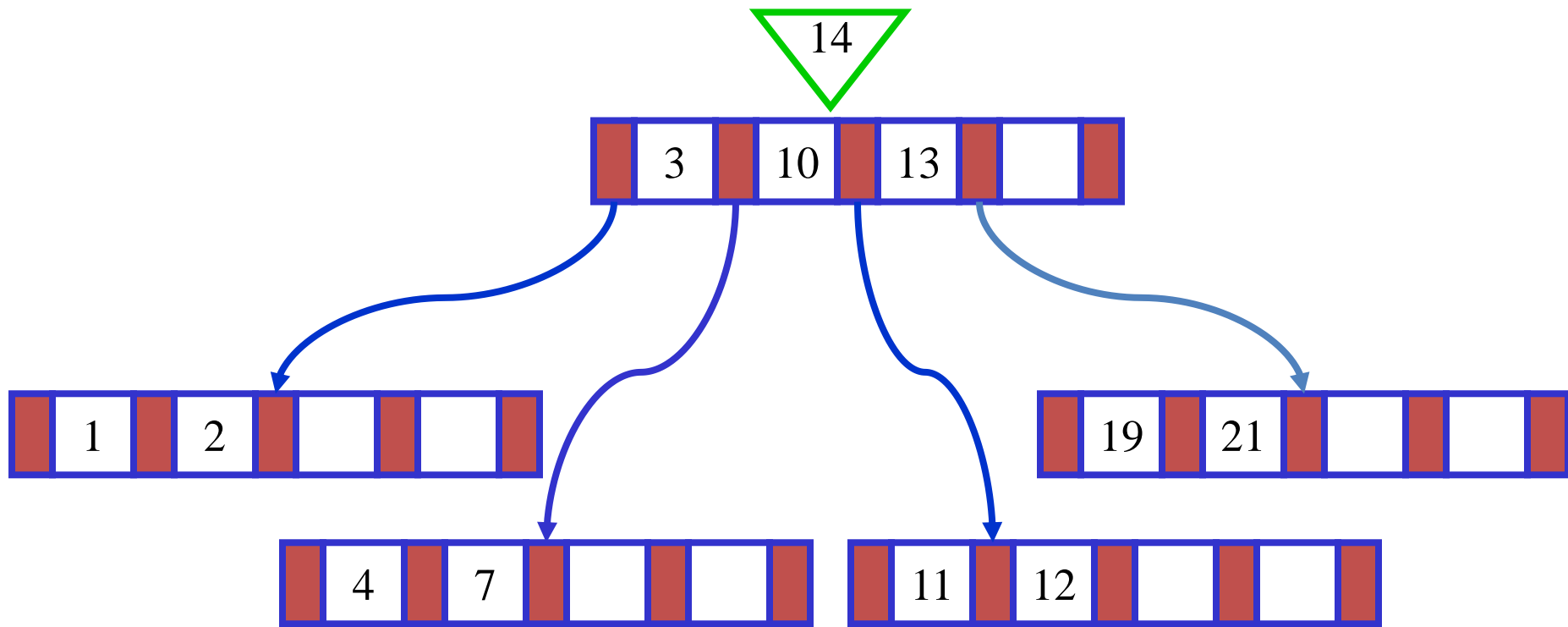

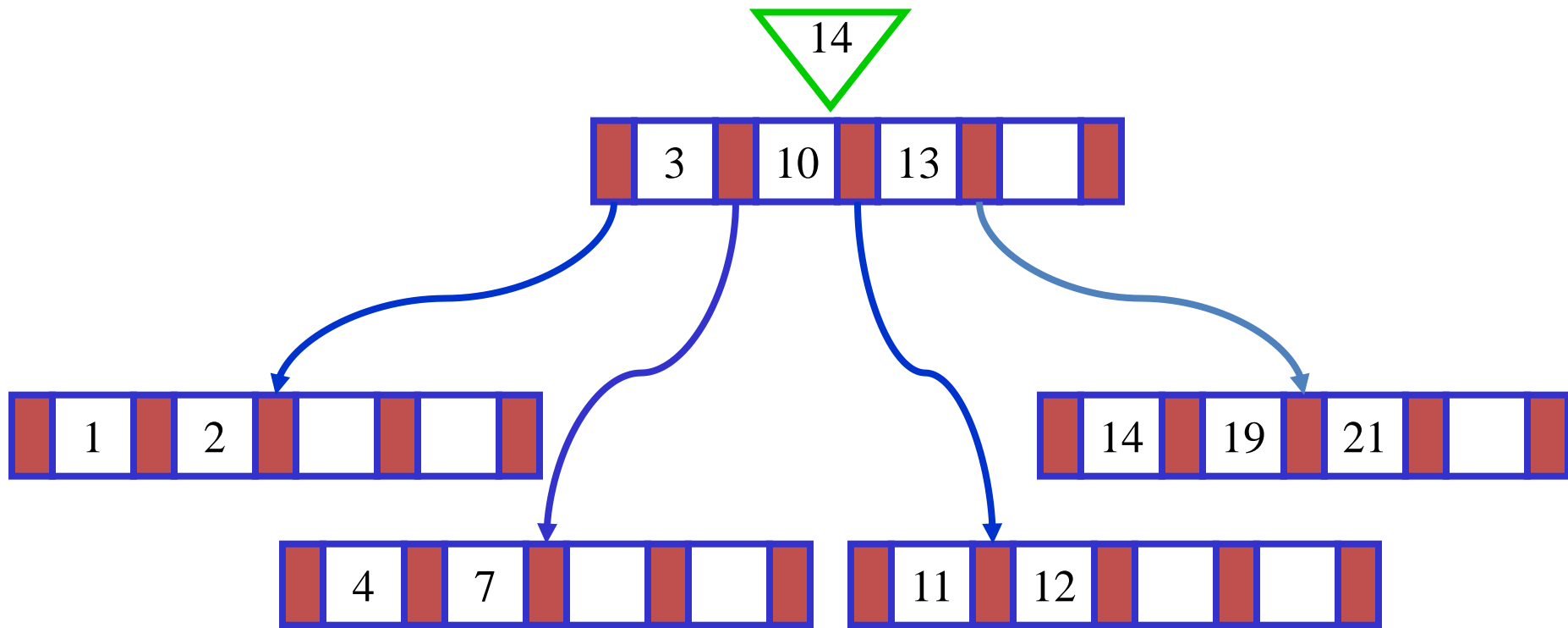

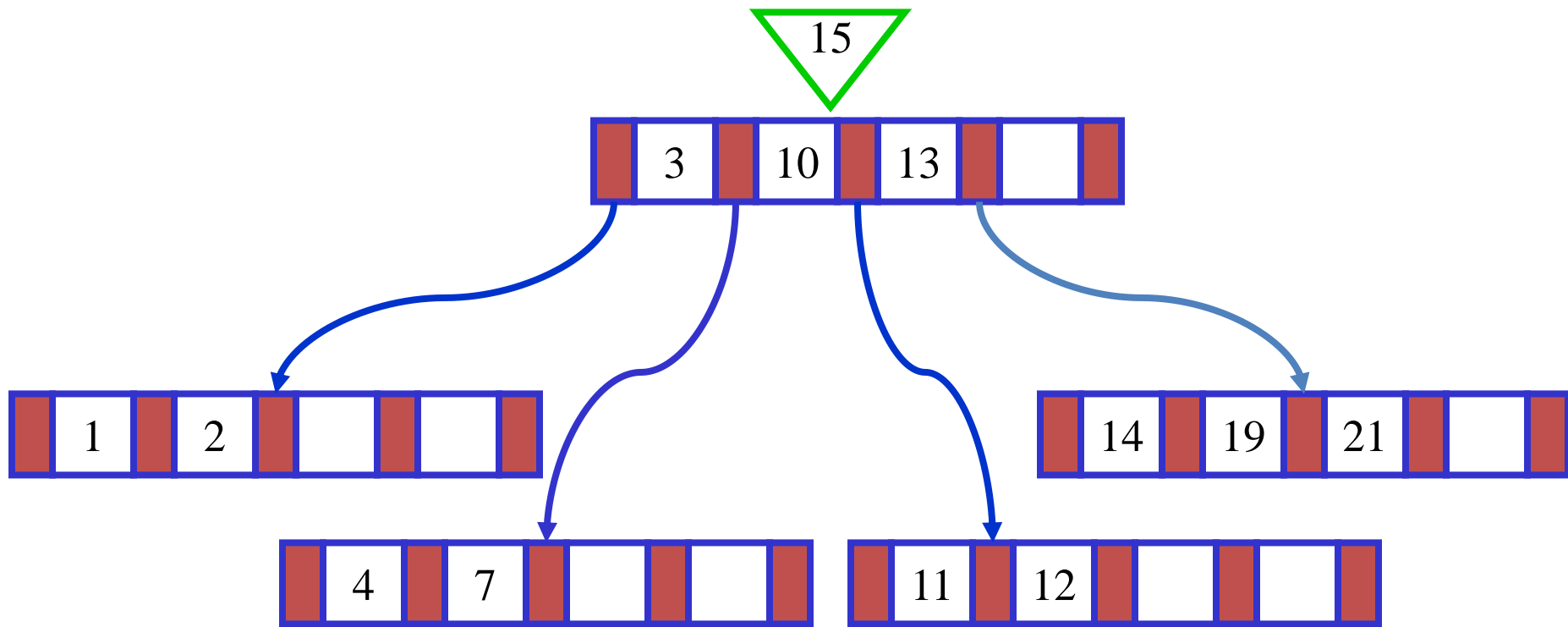

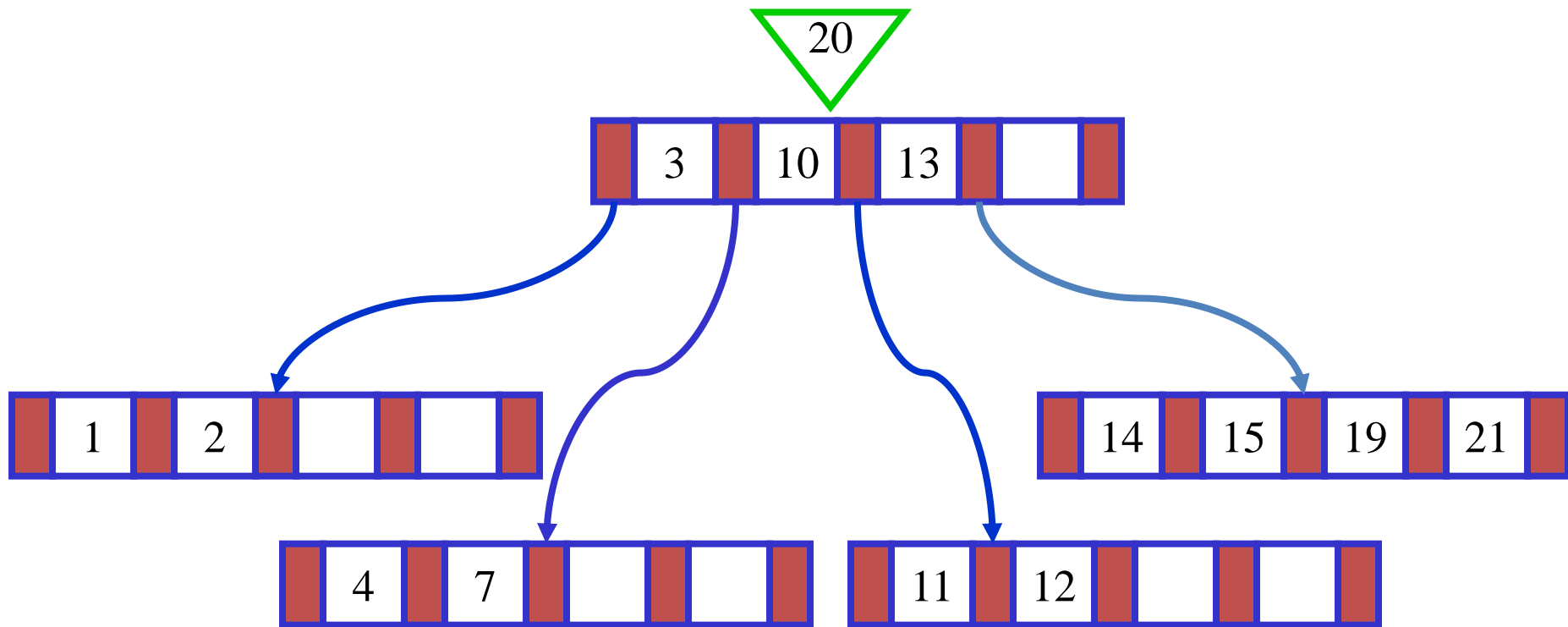

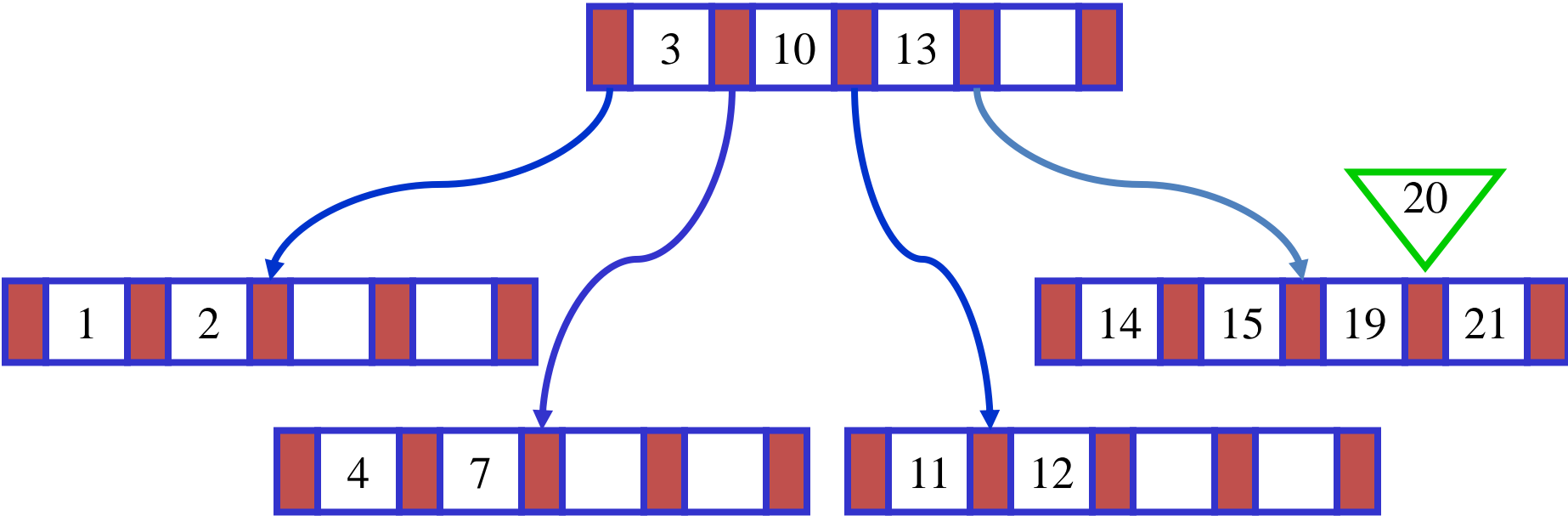

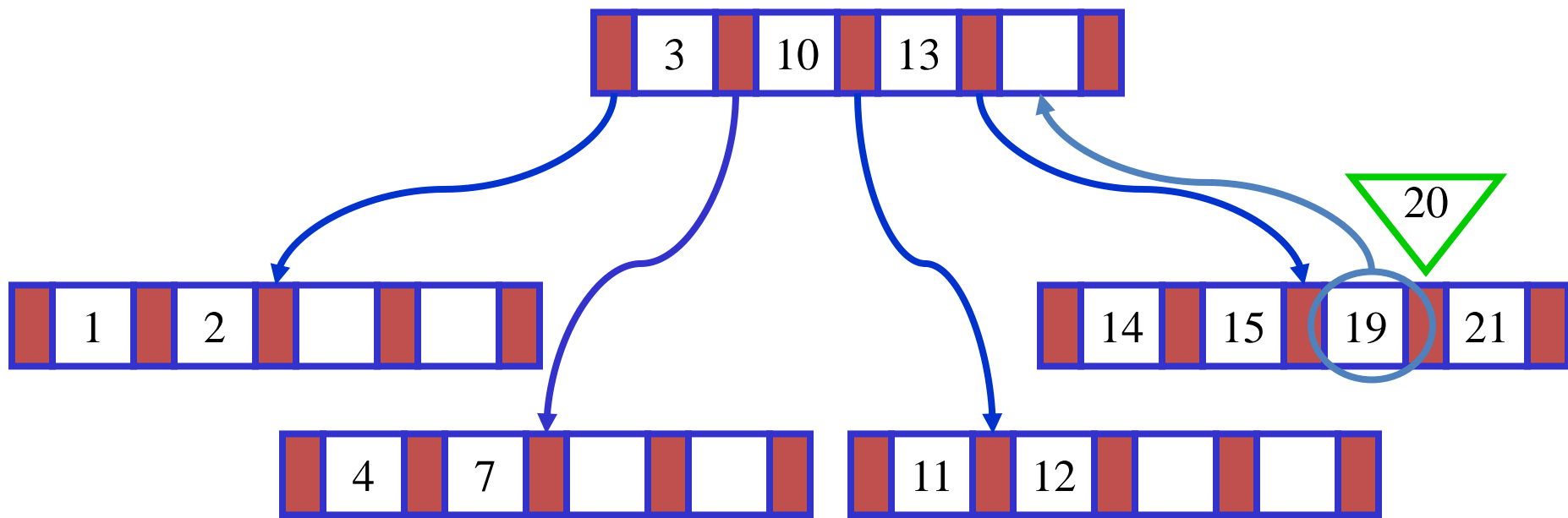



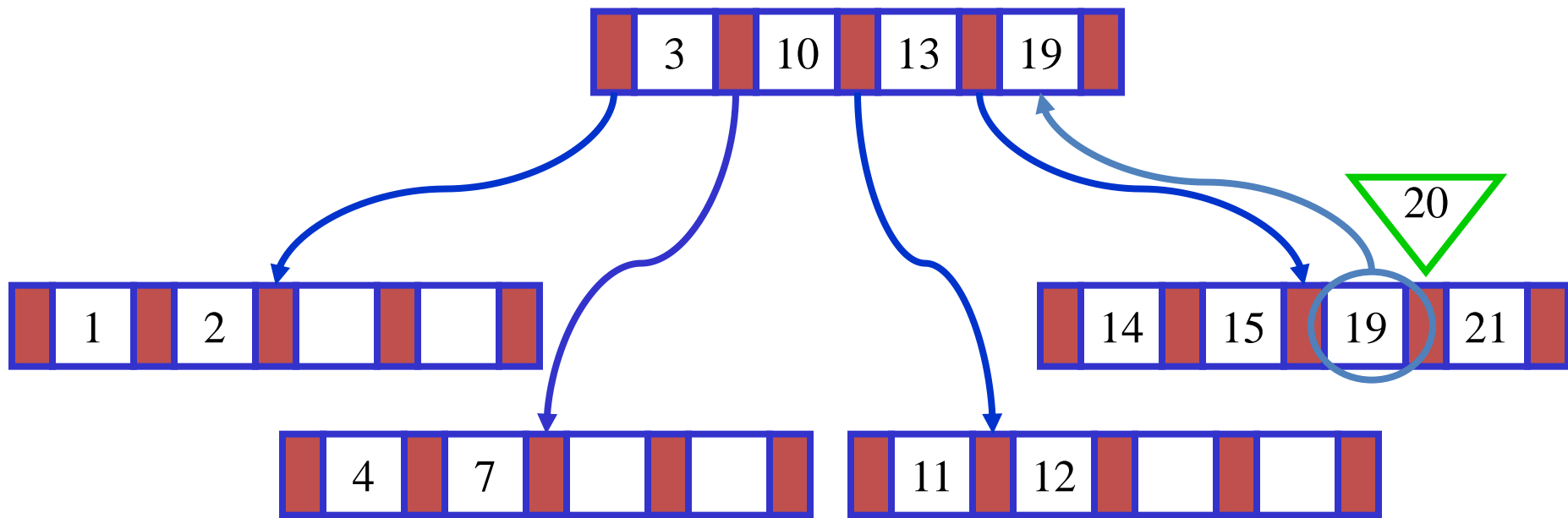

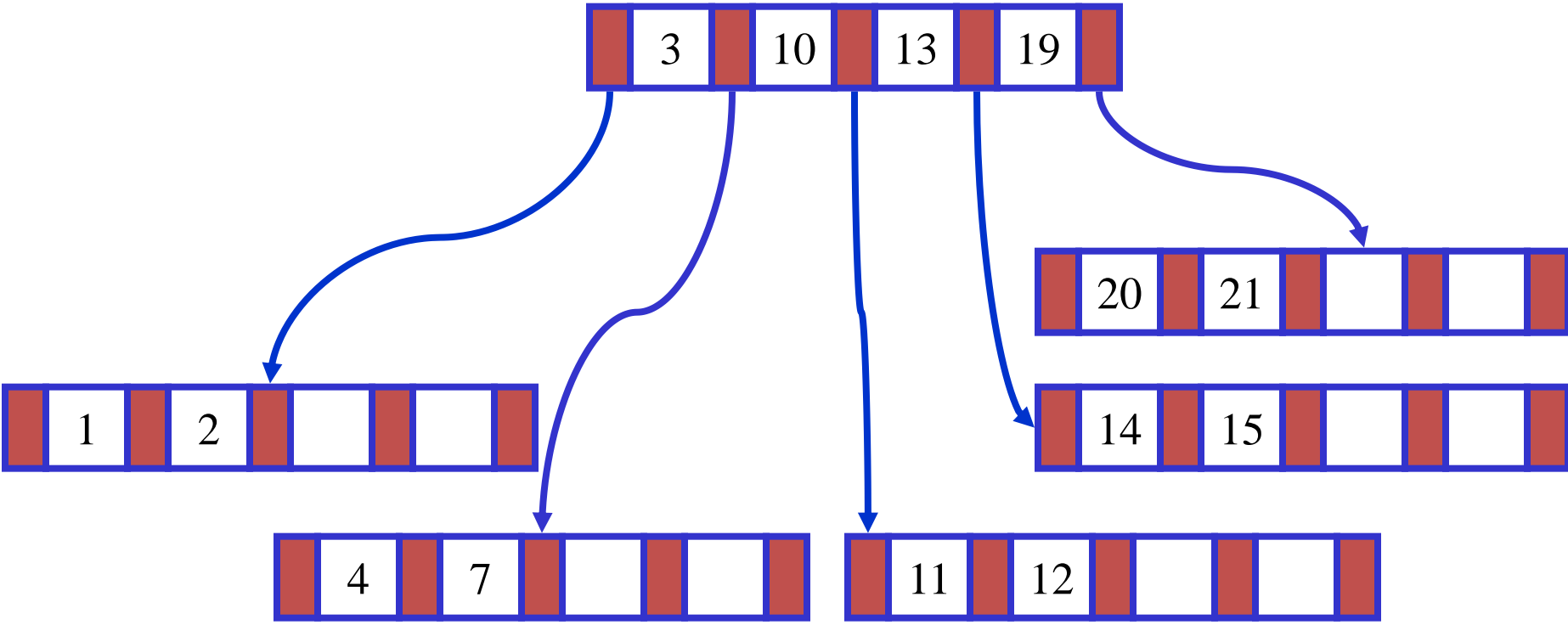

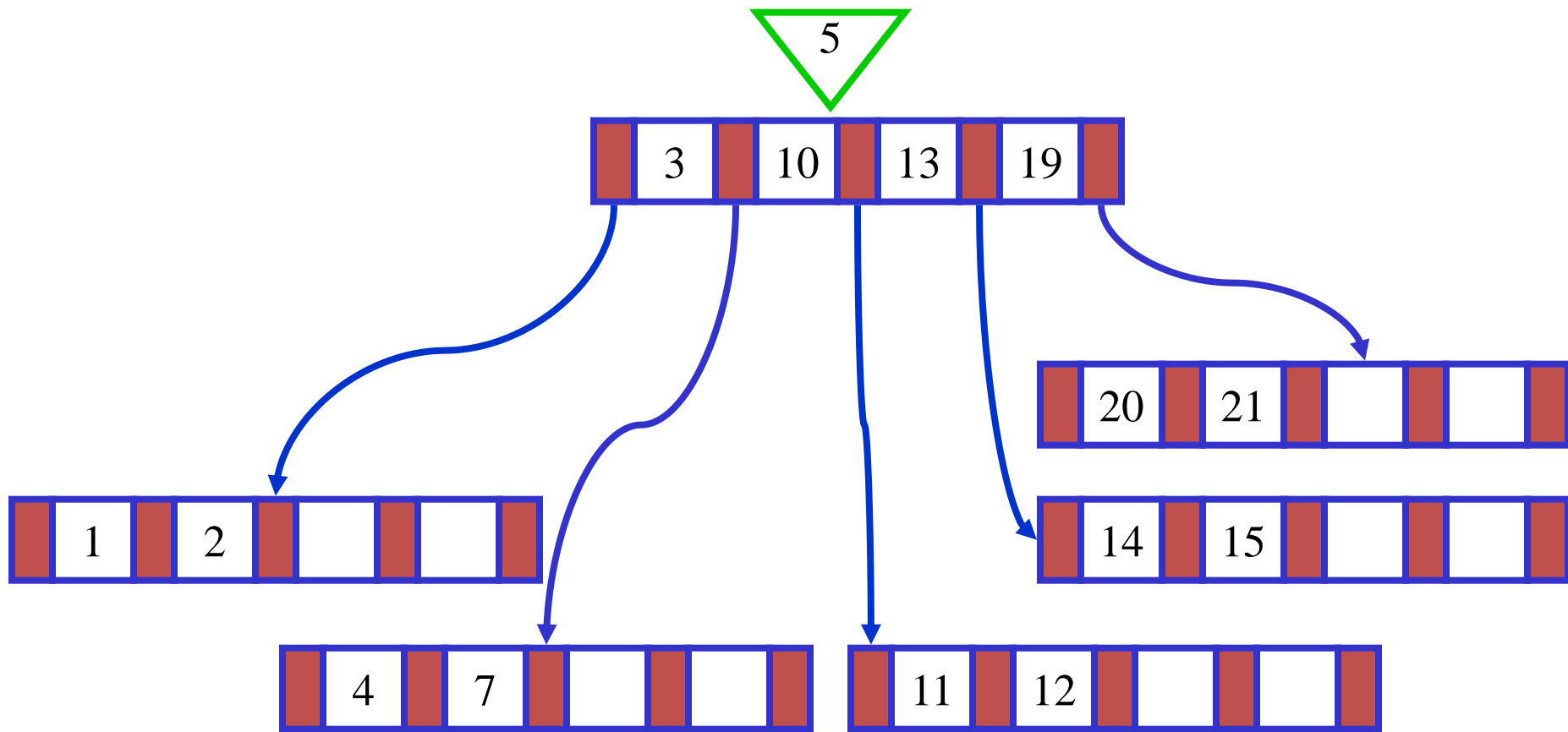

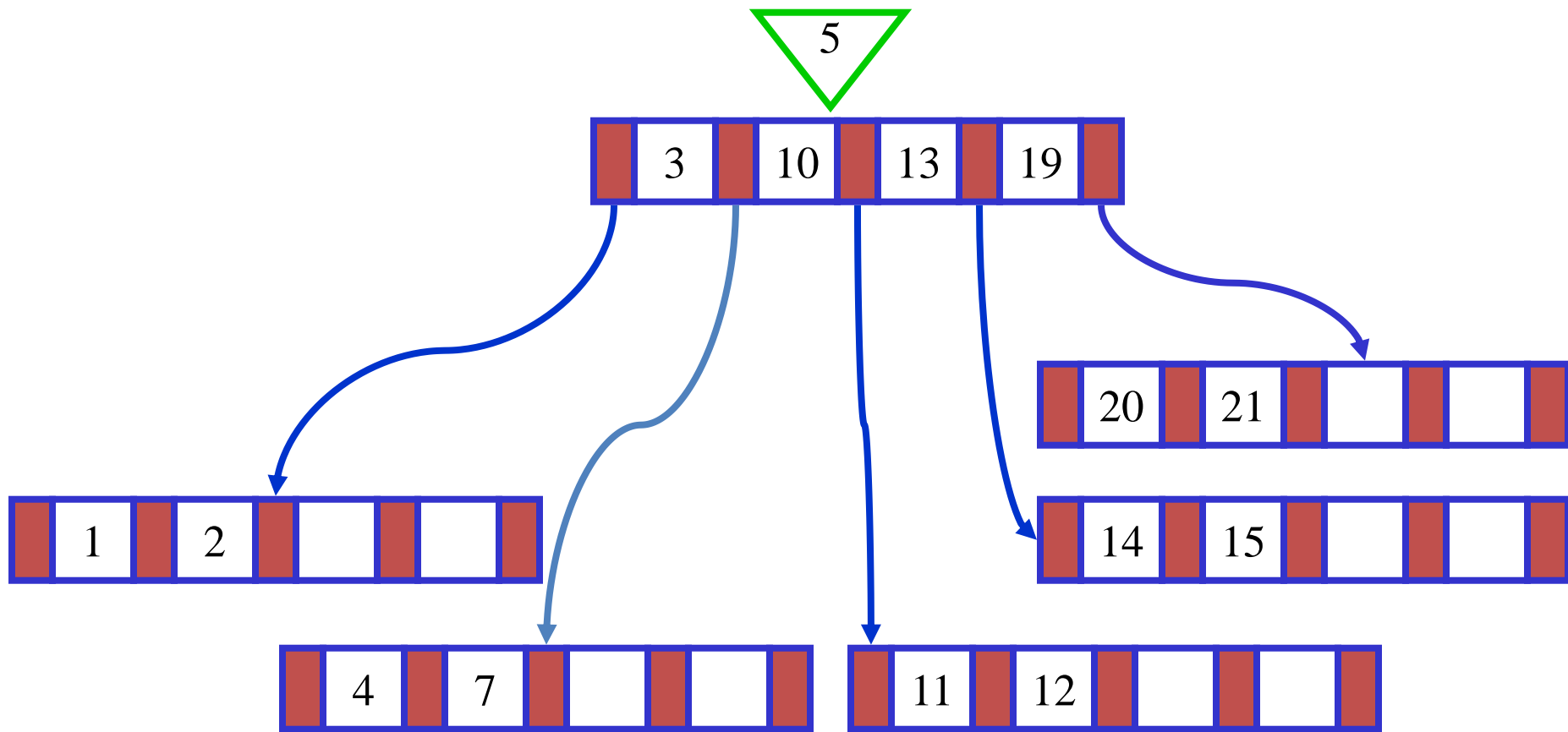

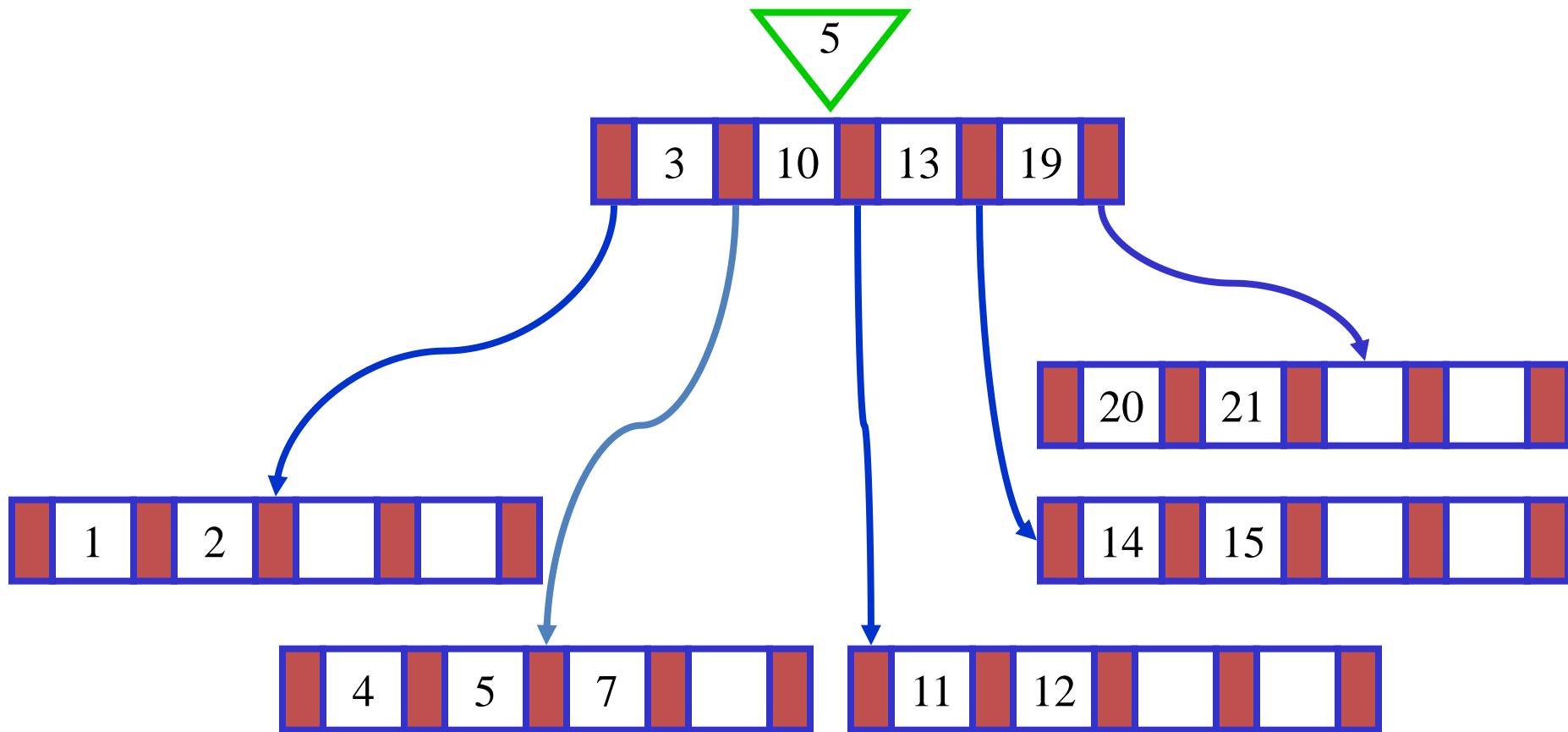

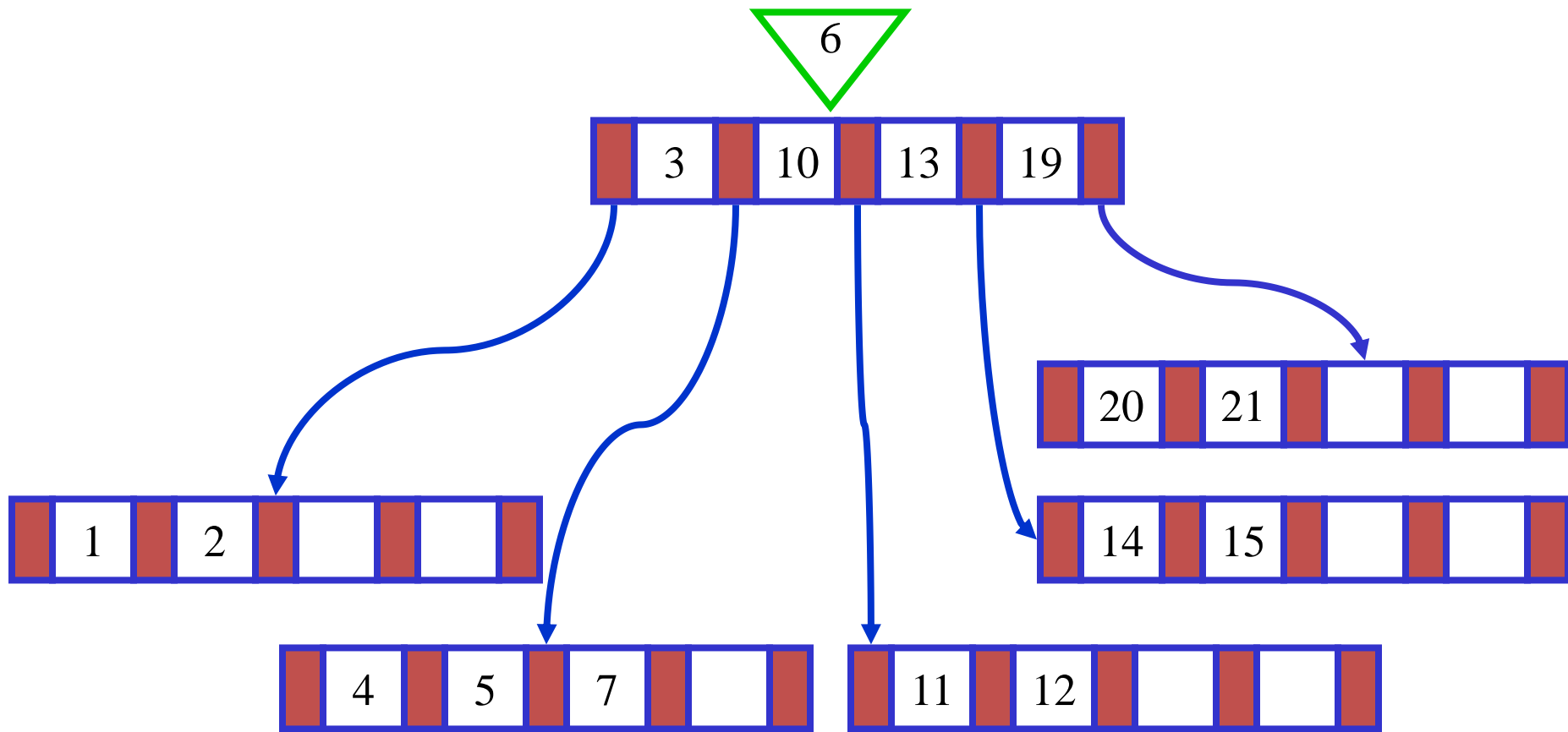

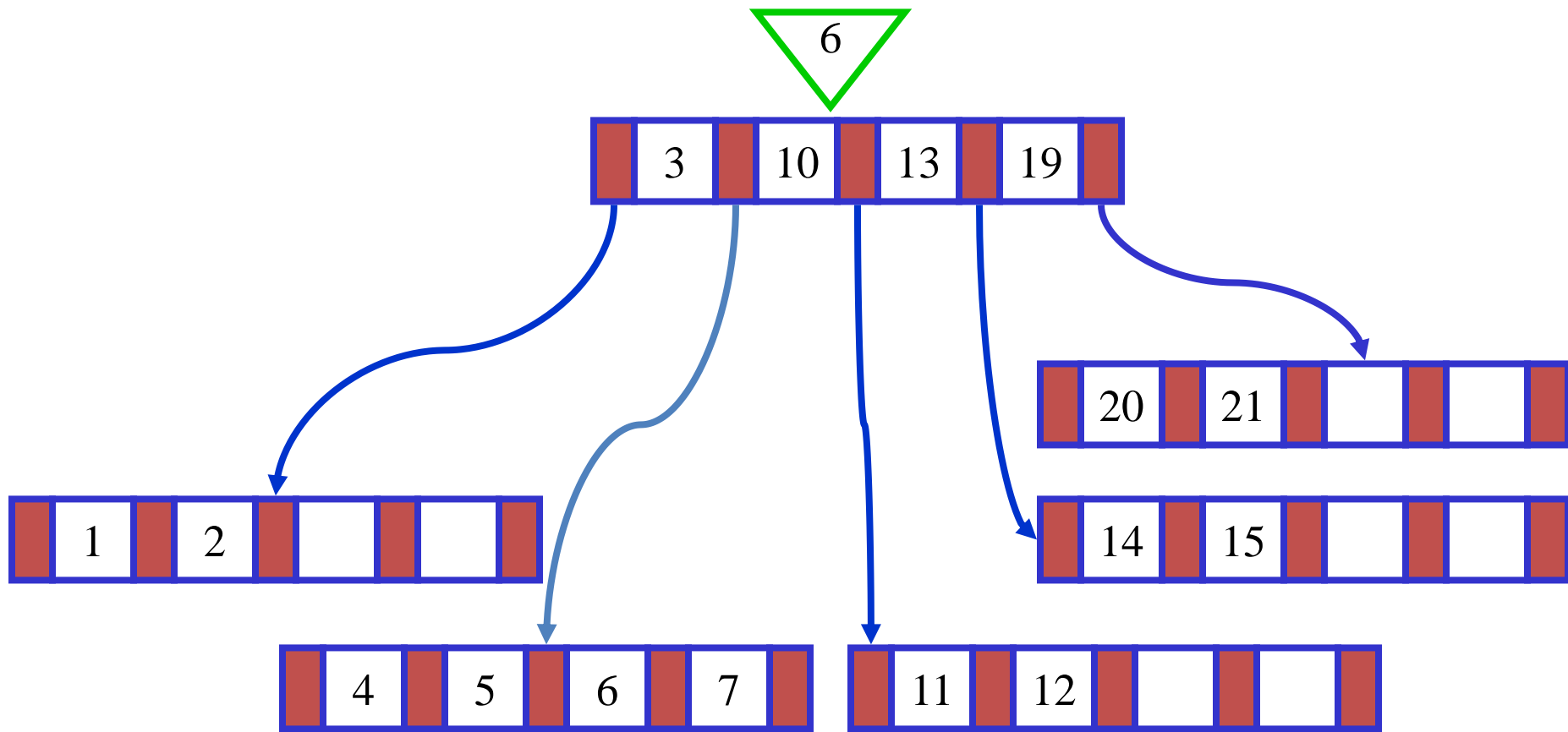

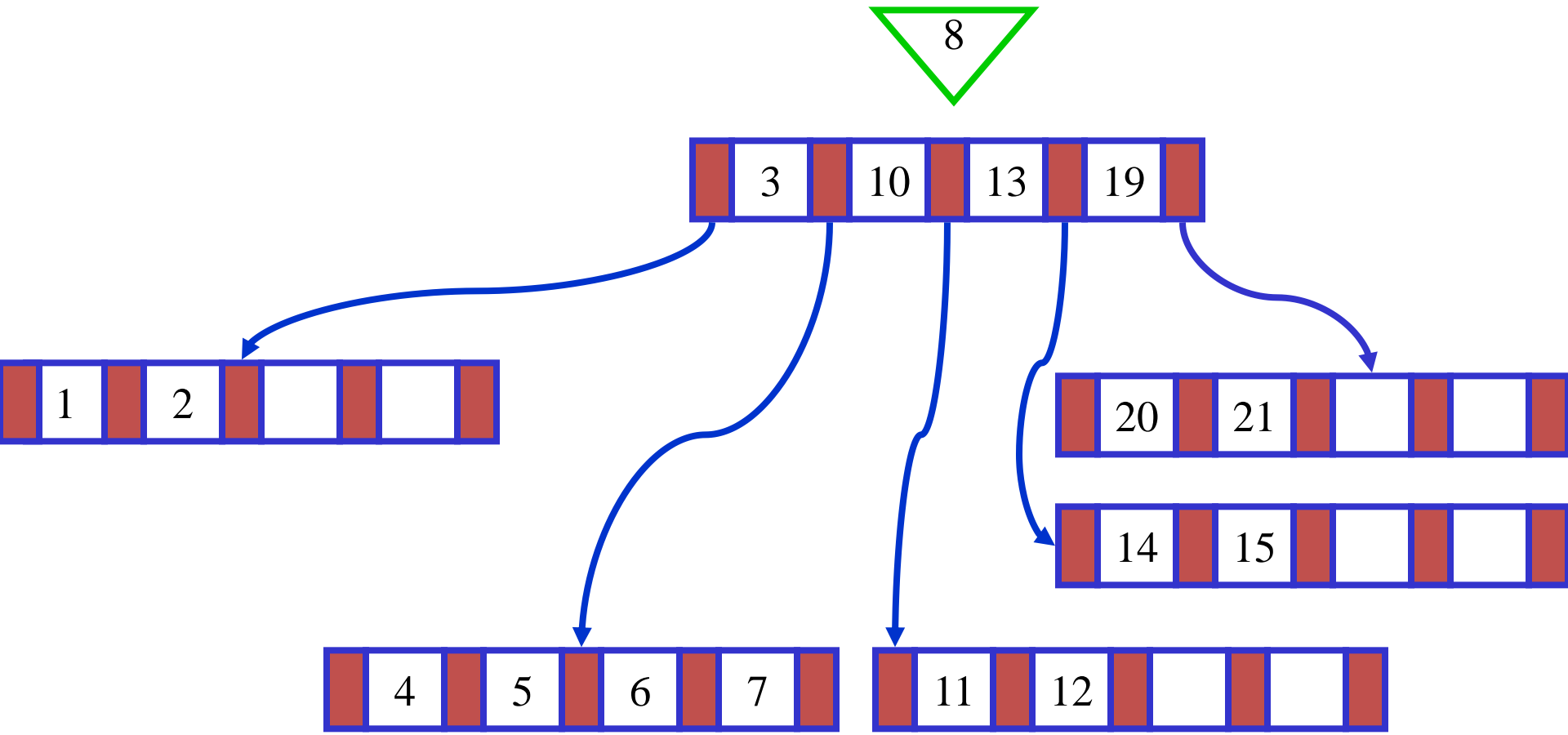



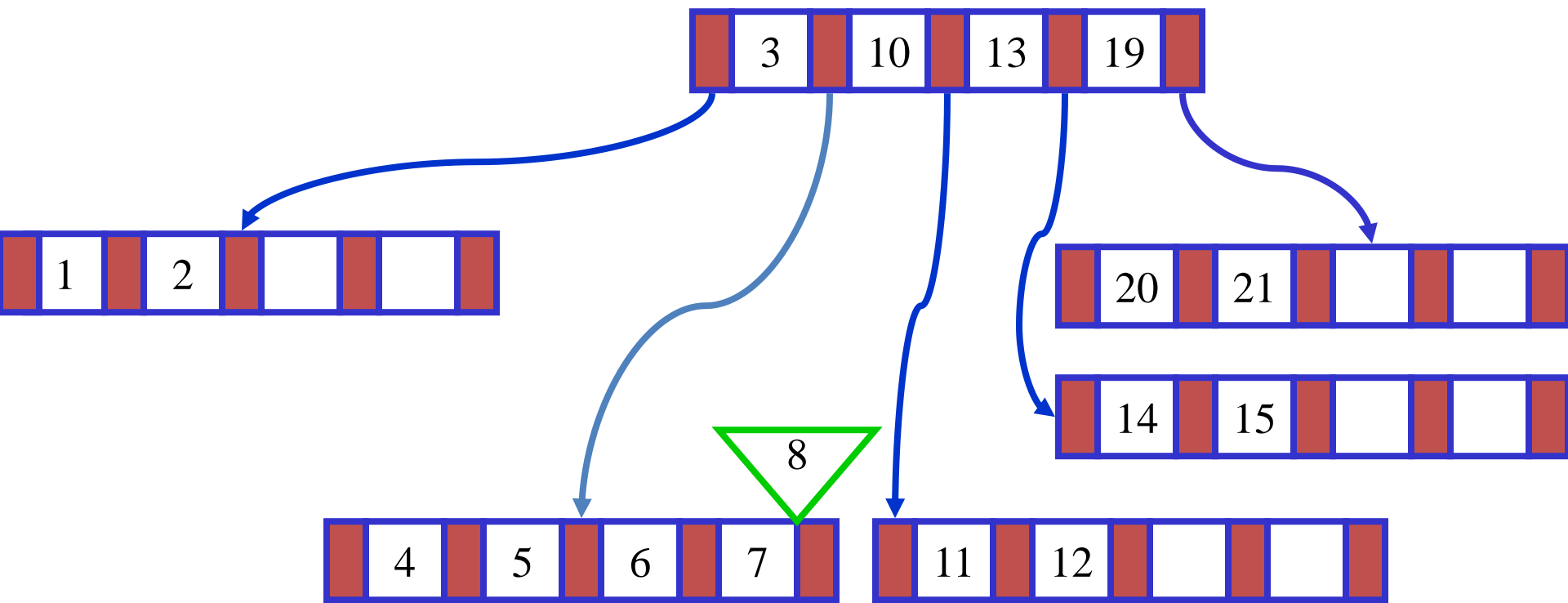

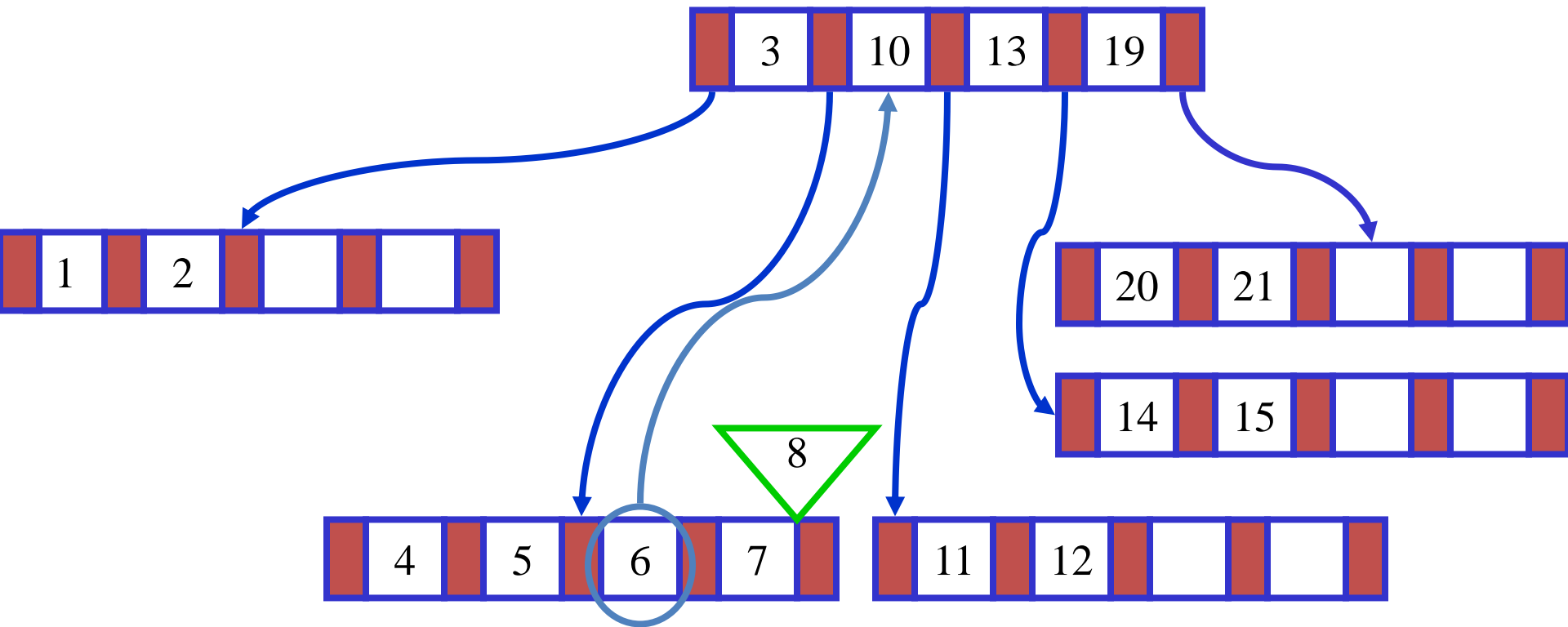

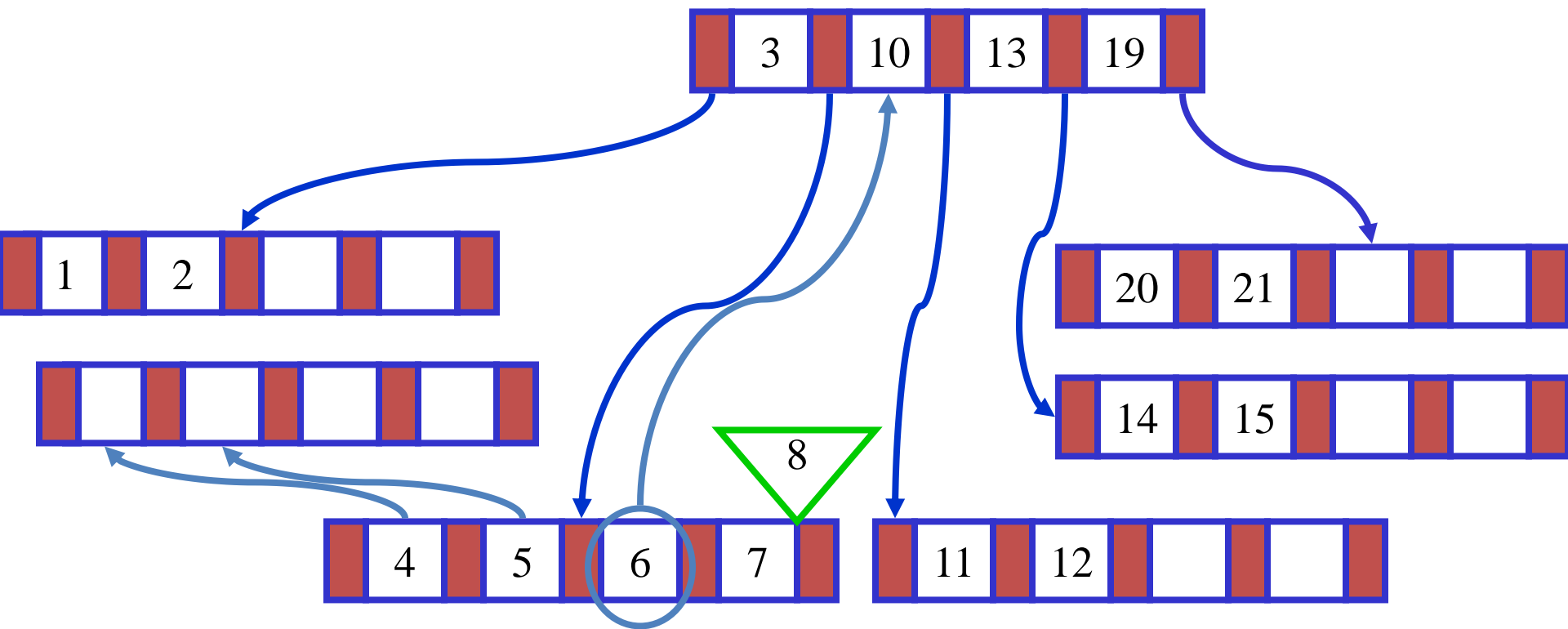

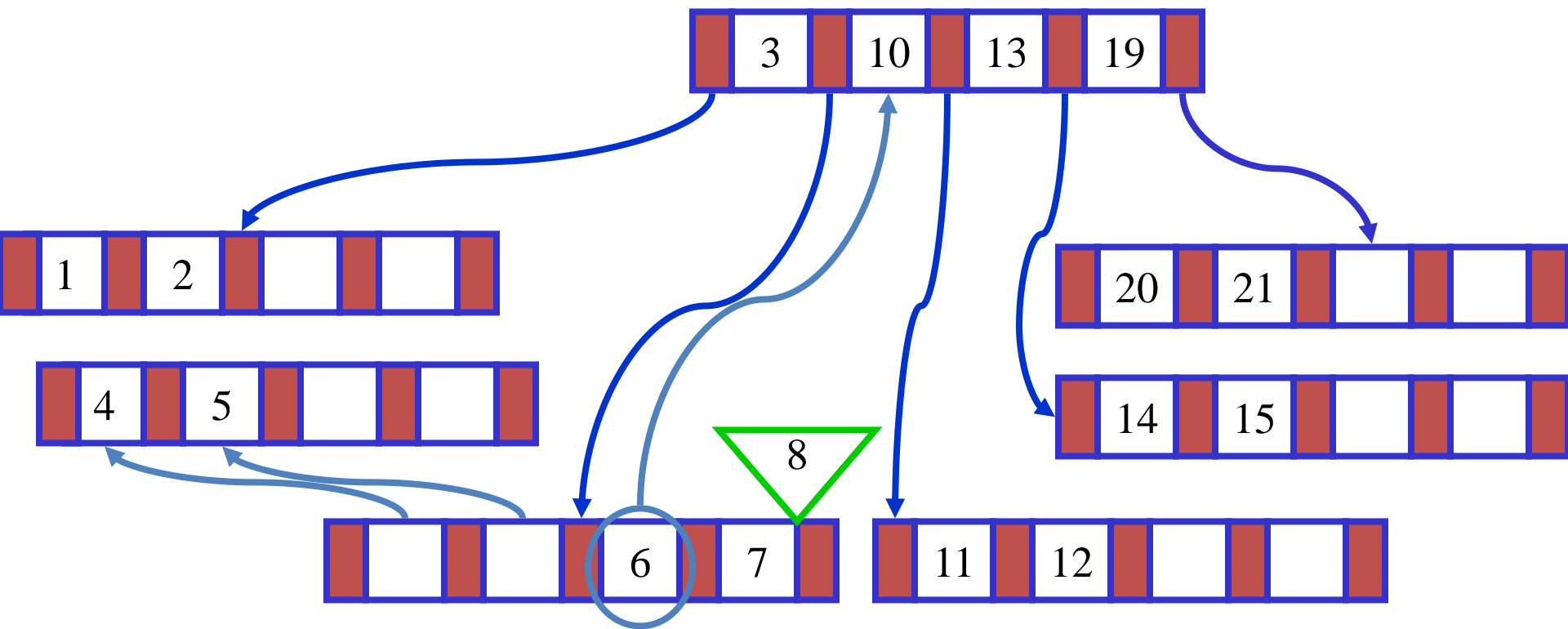

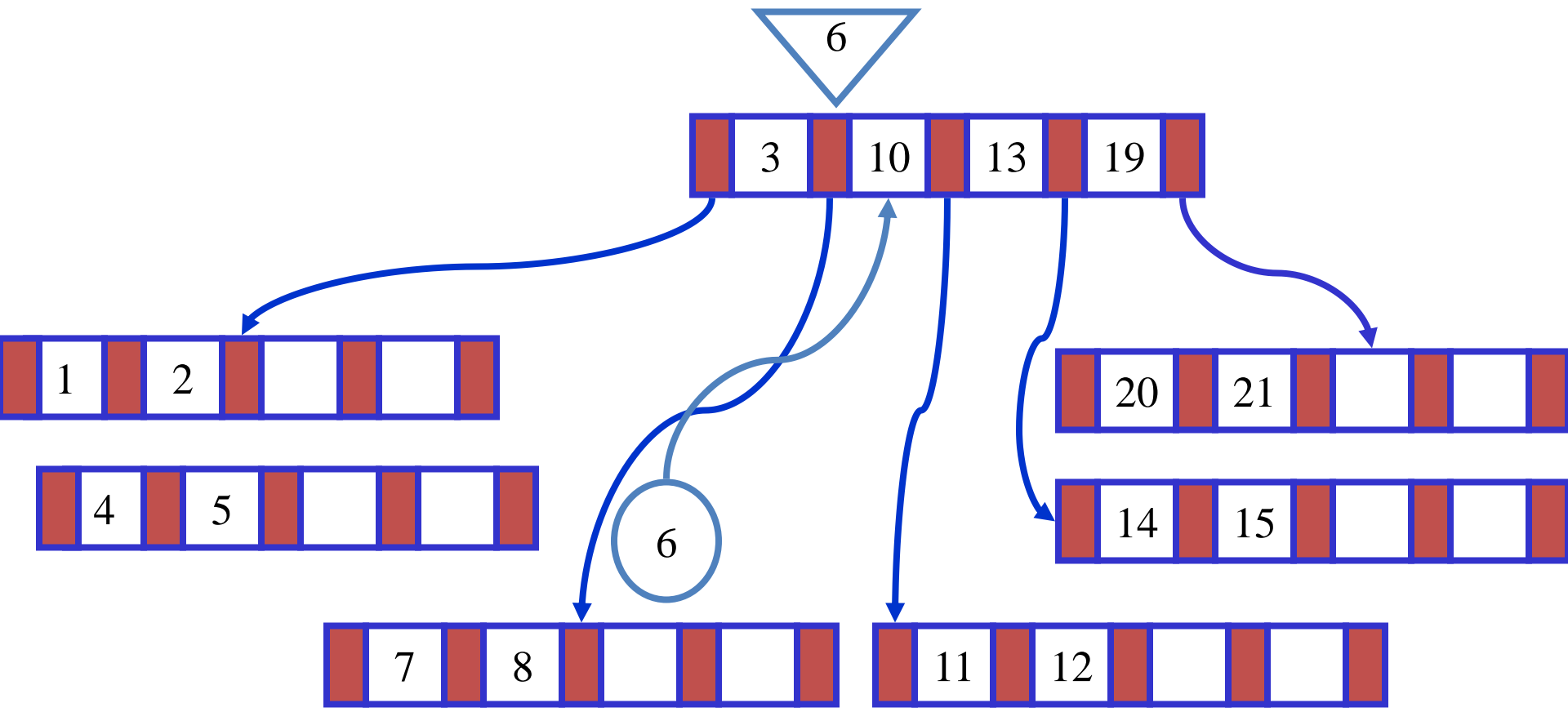

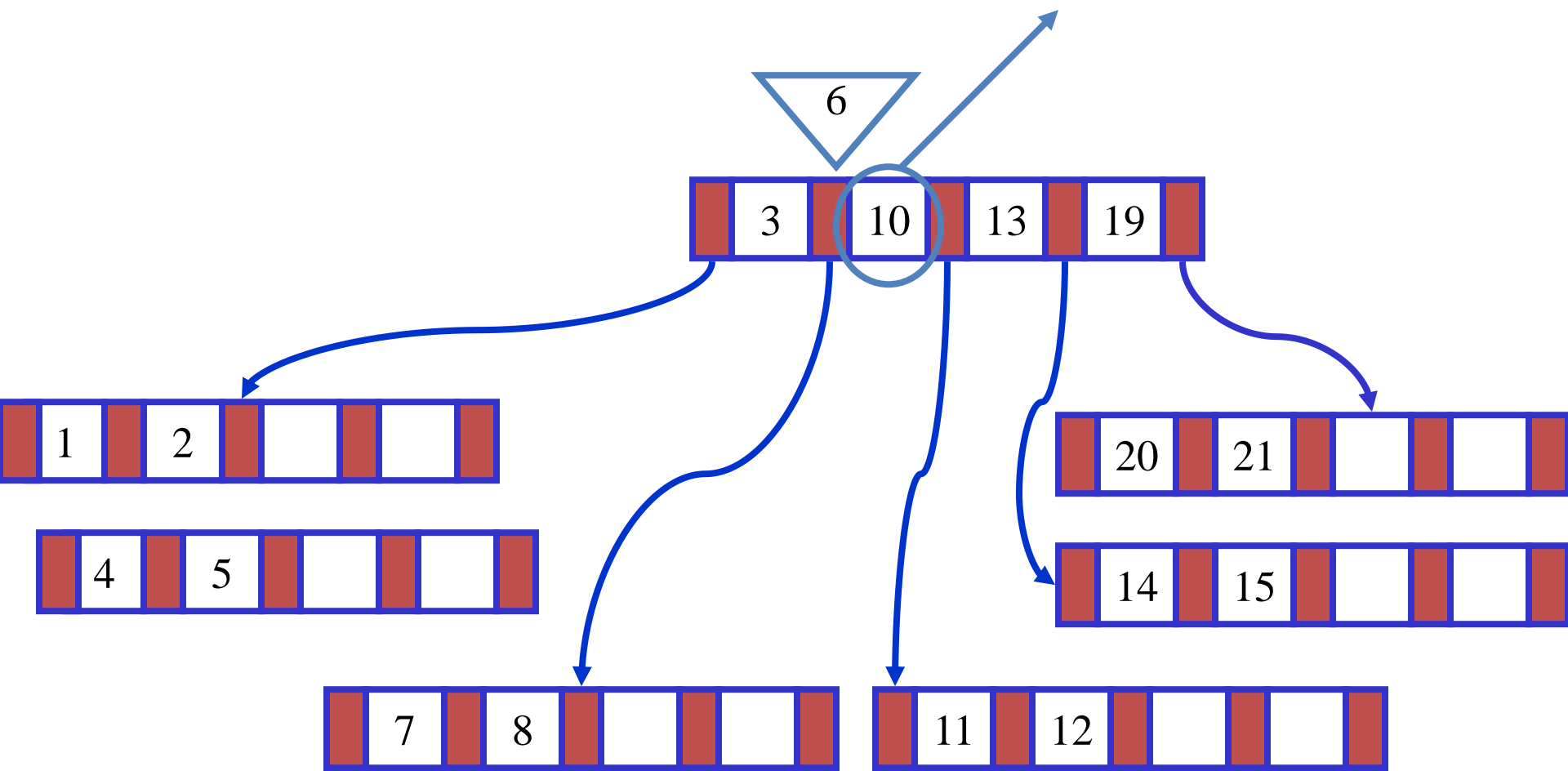

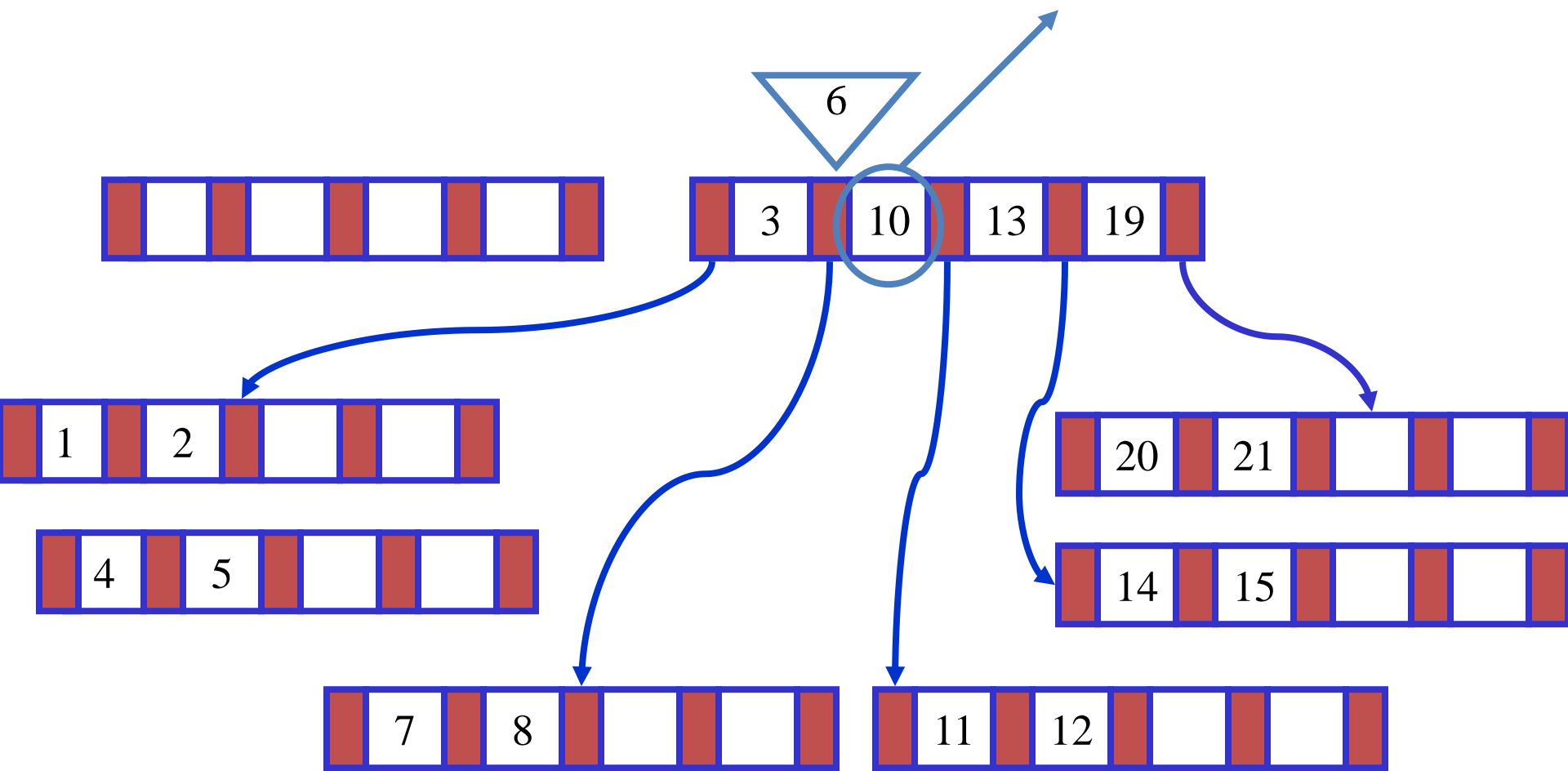

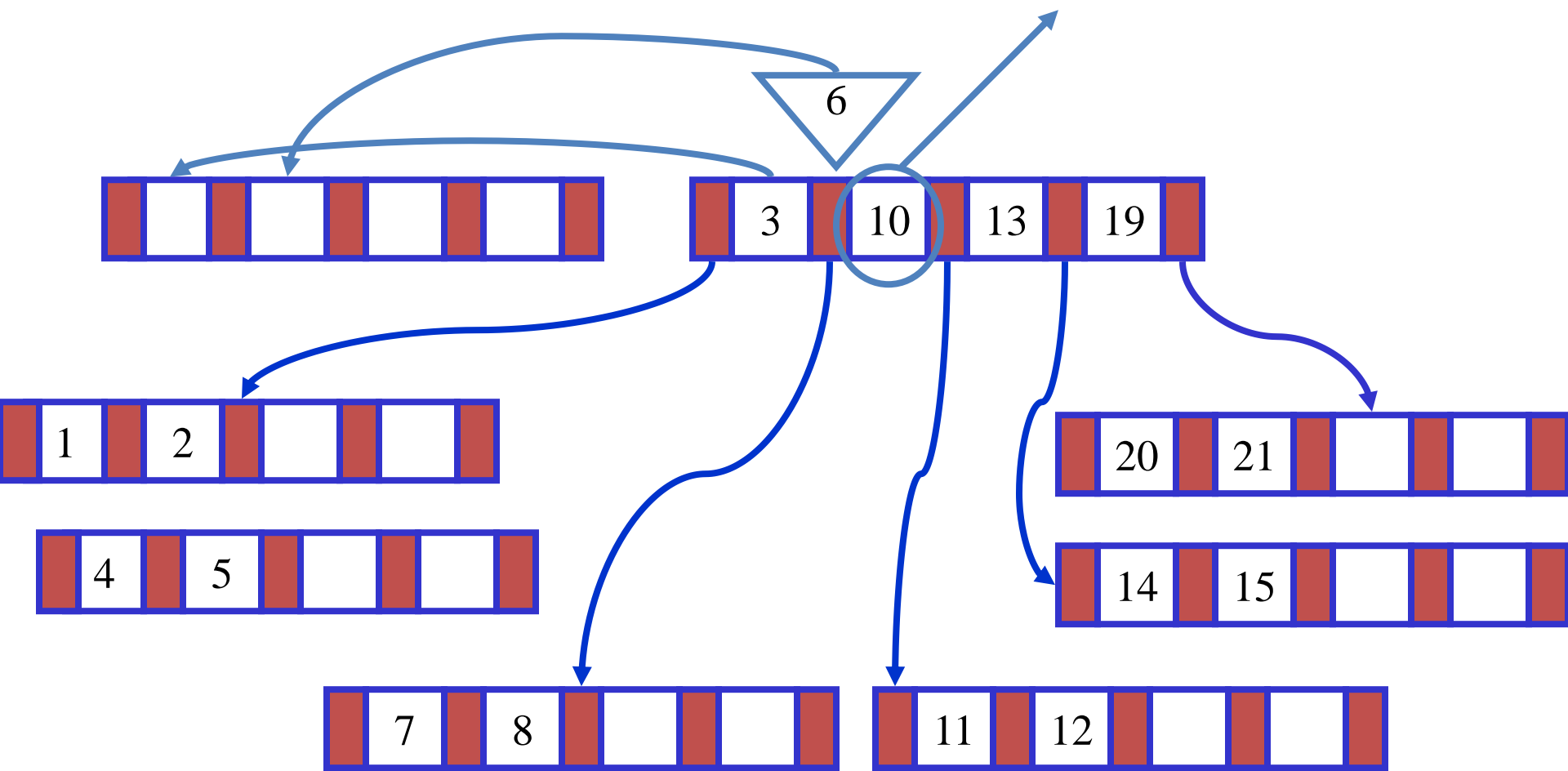



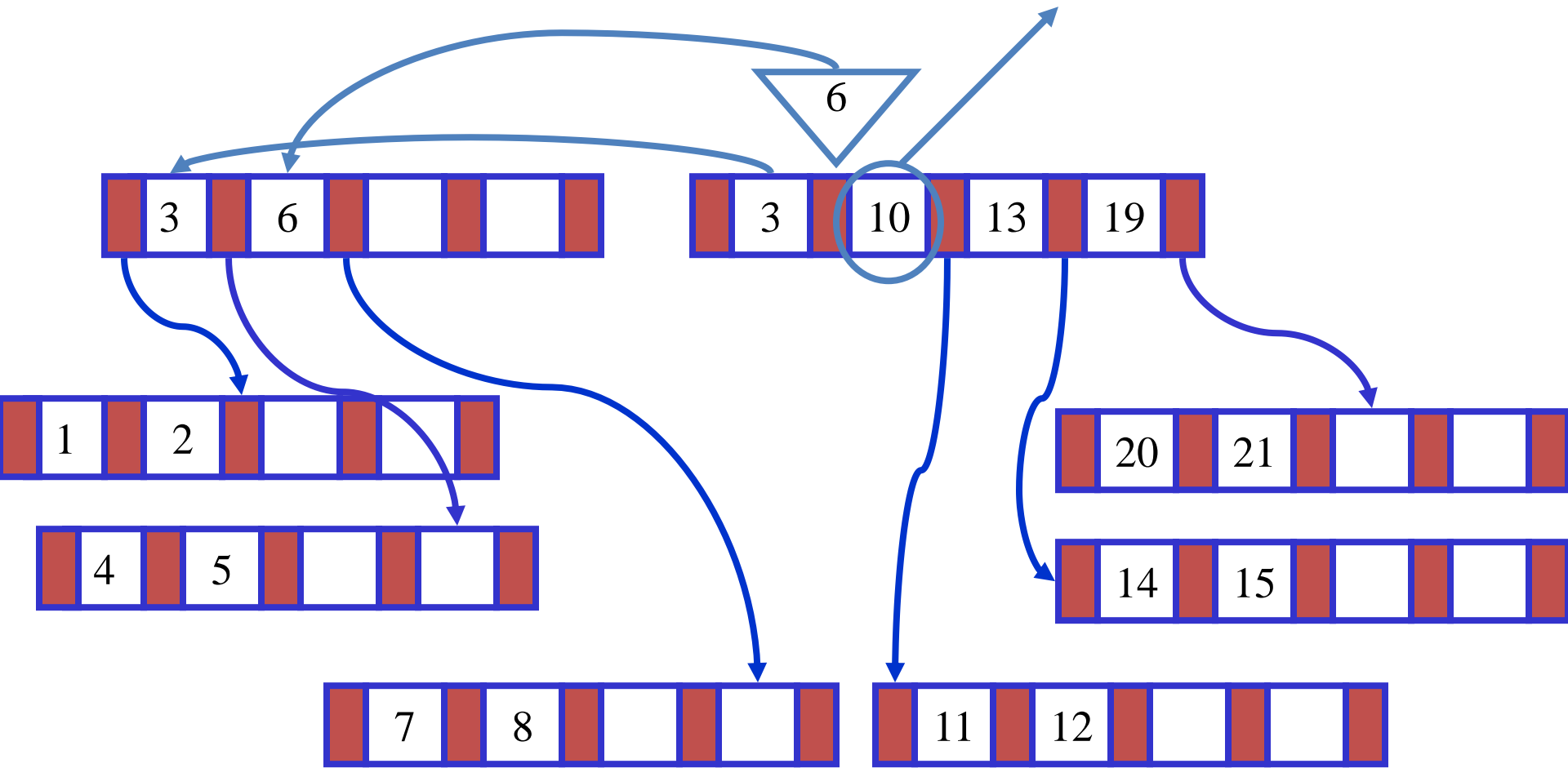

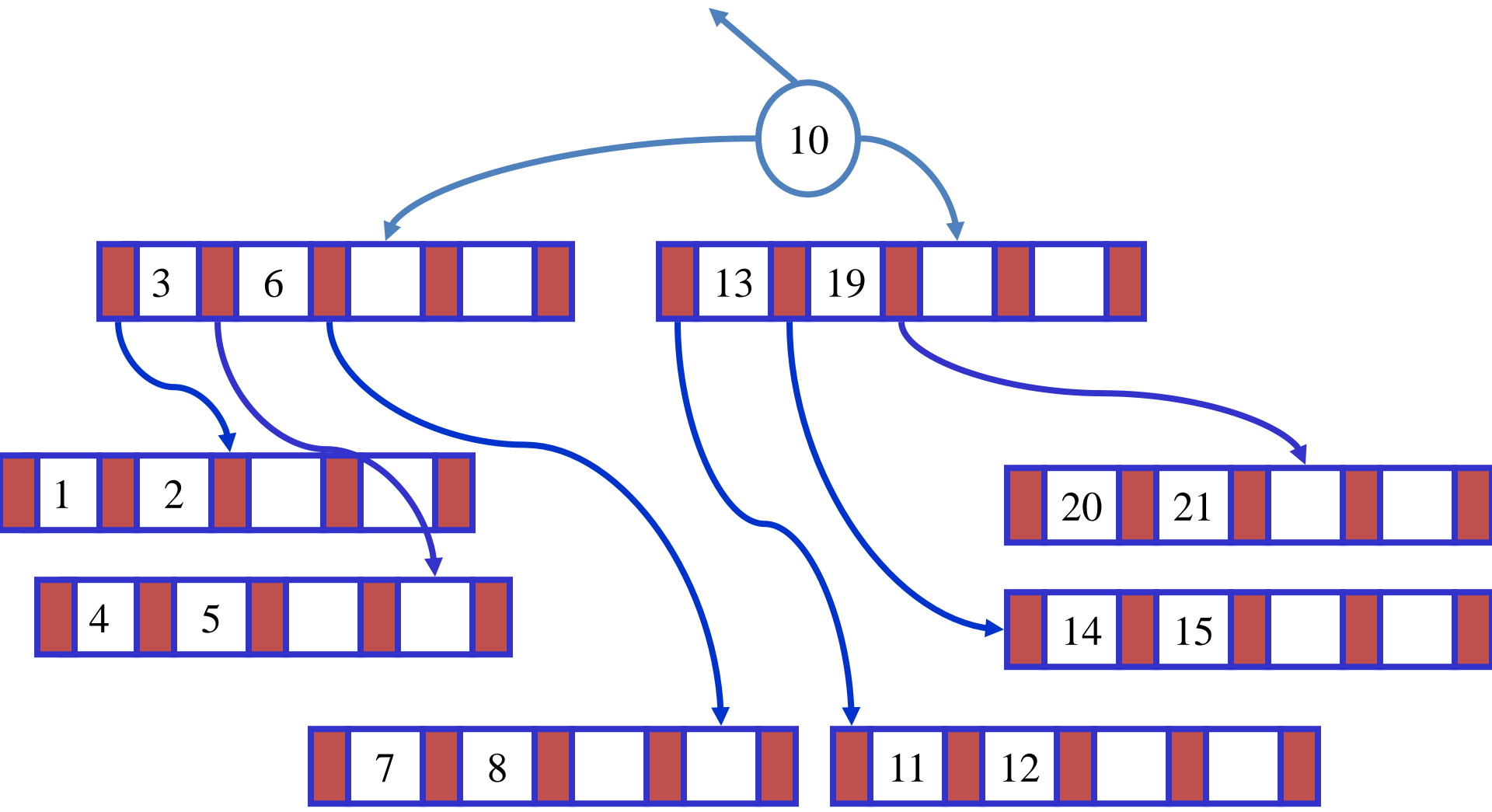

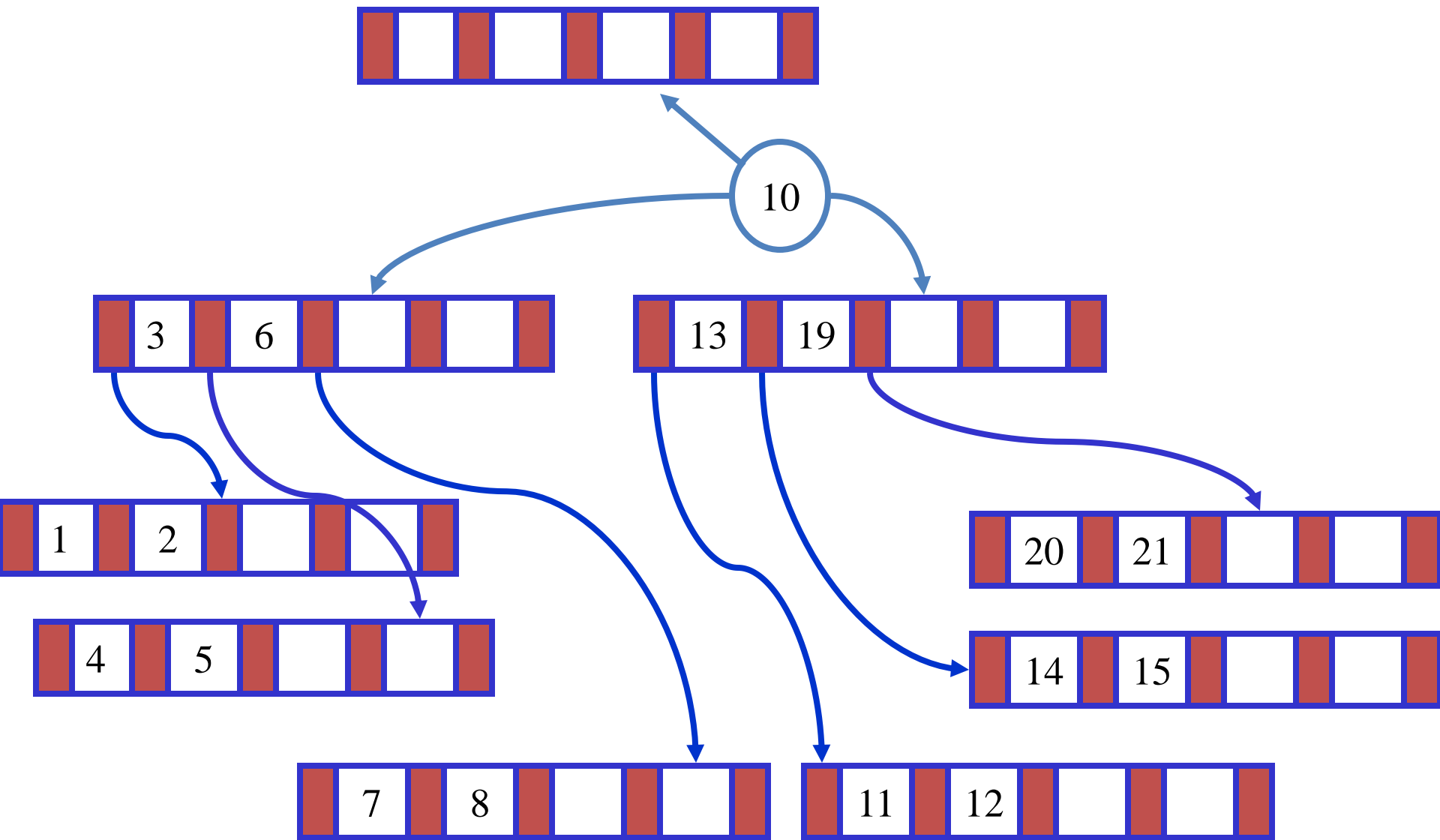

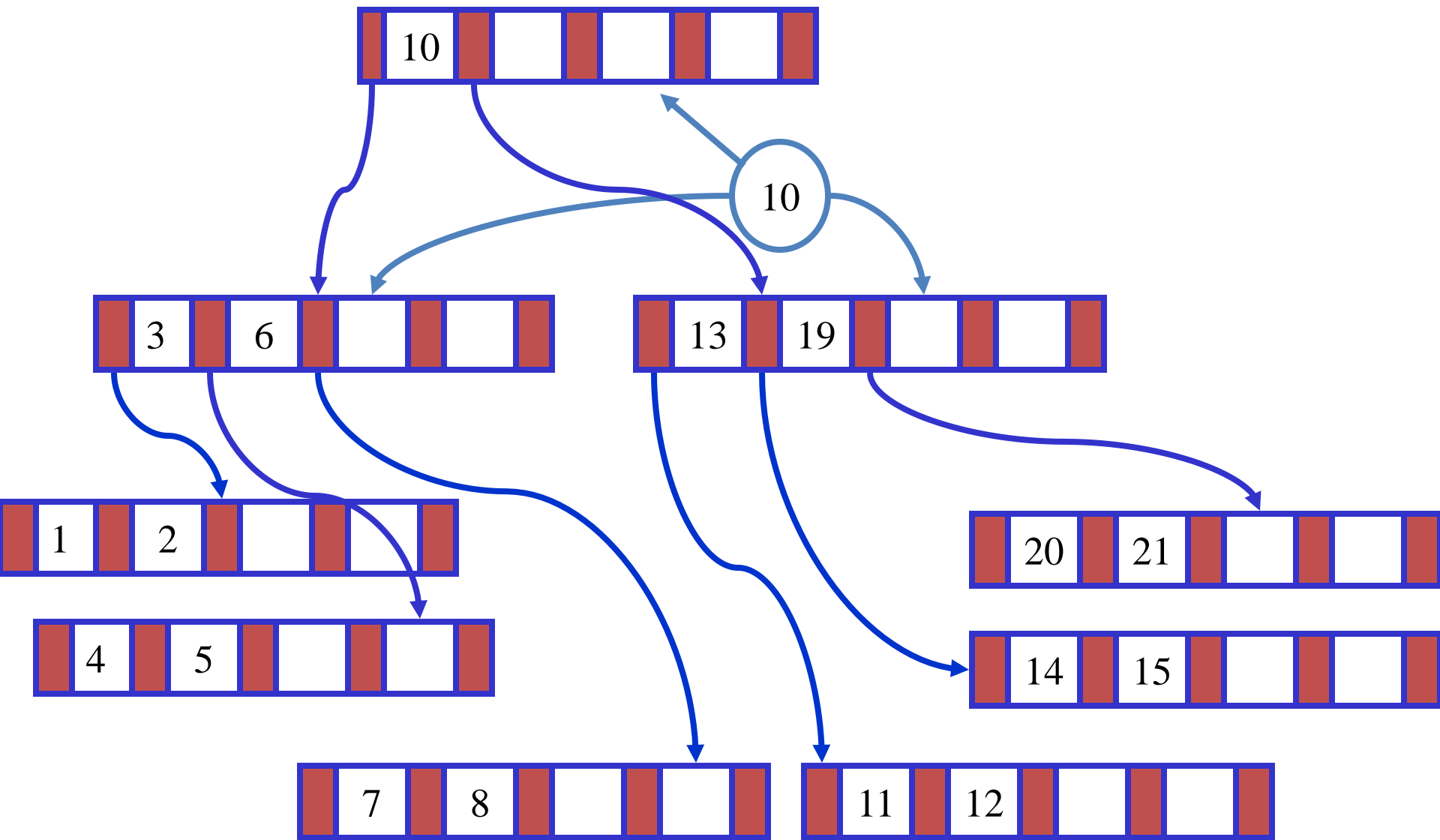

B-Baum mit Minimaler Speicherplatzausnutzung

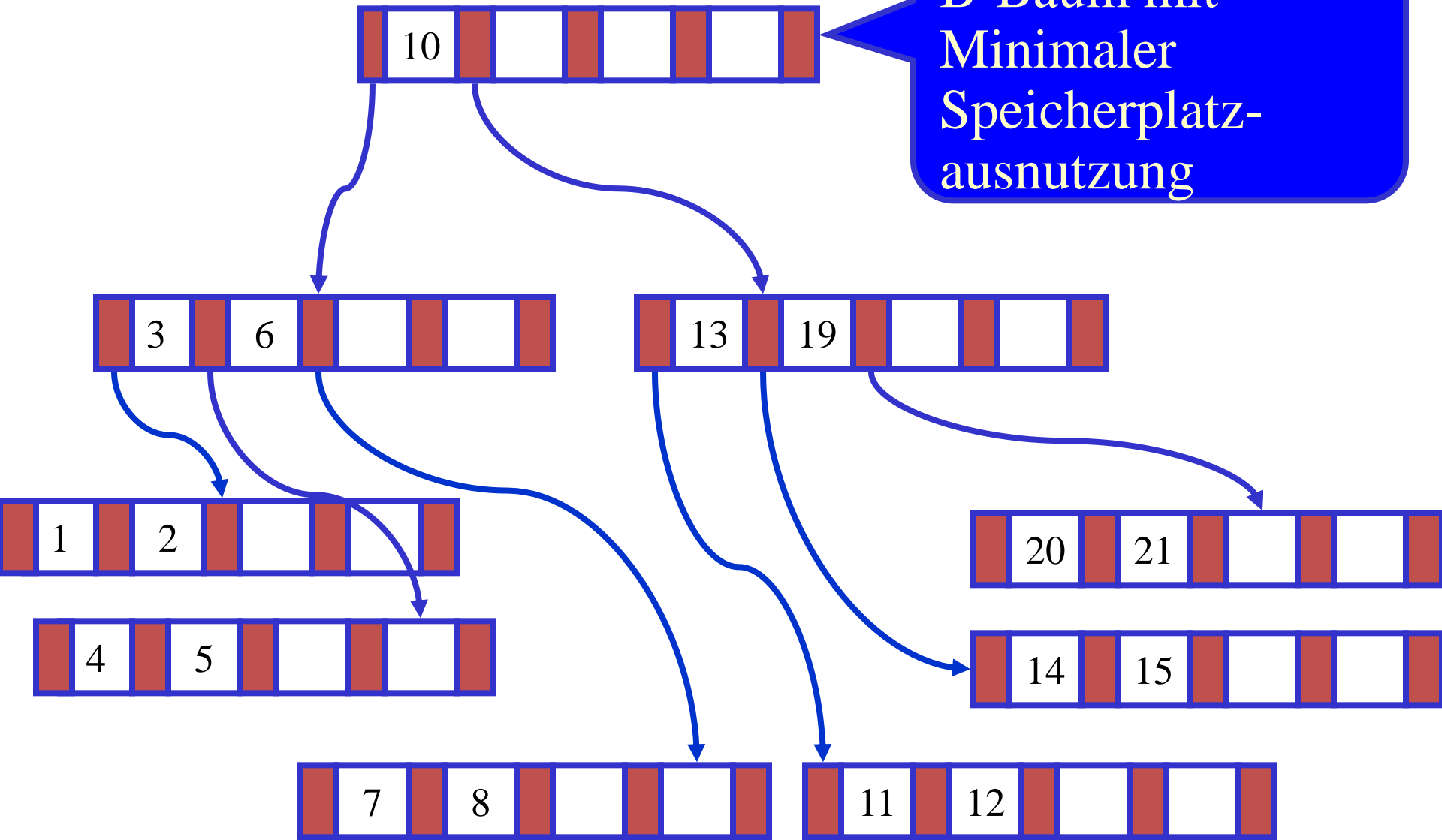

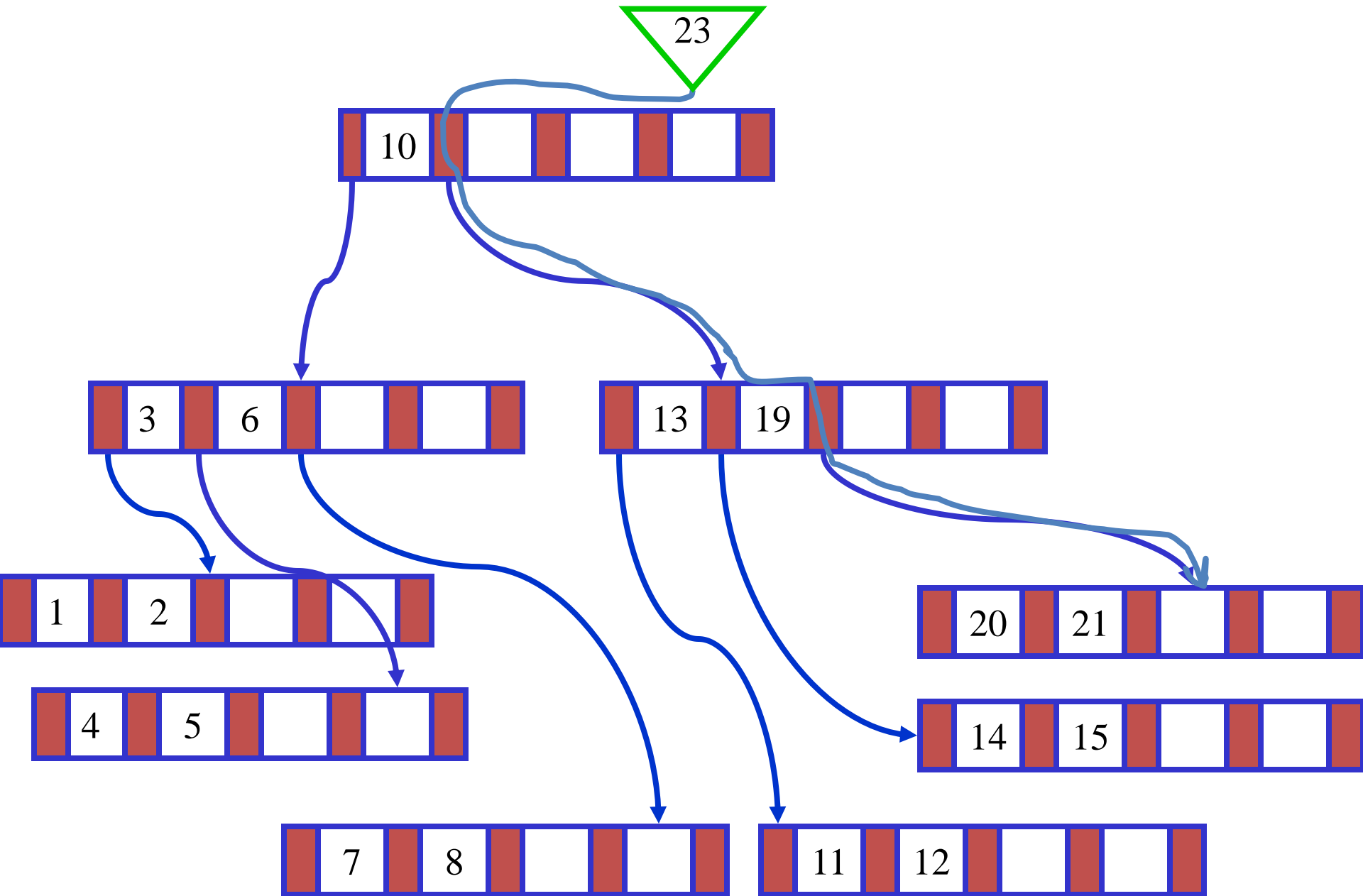

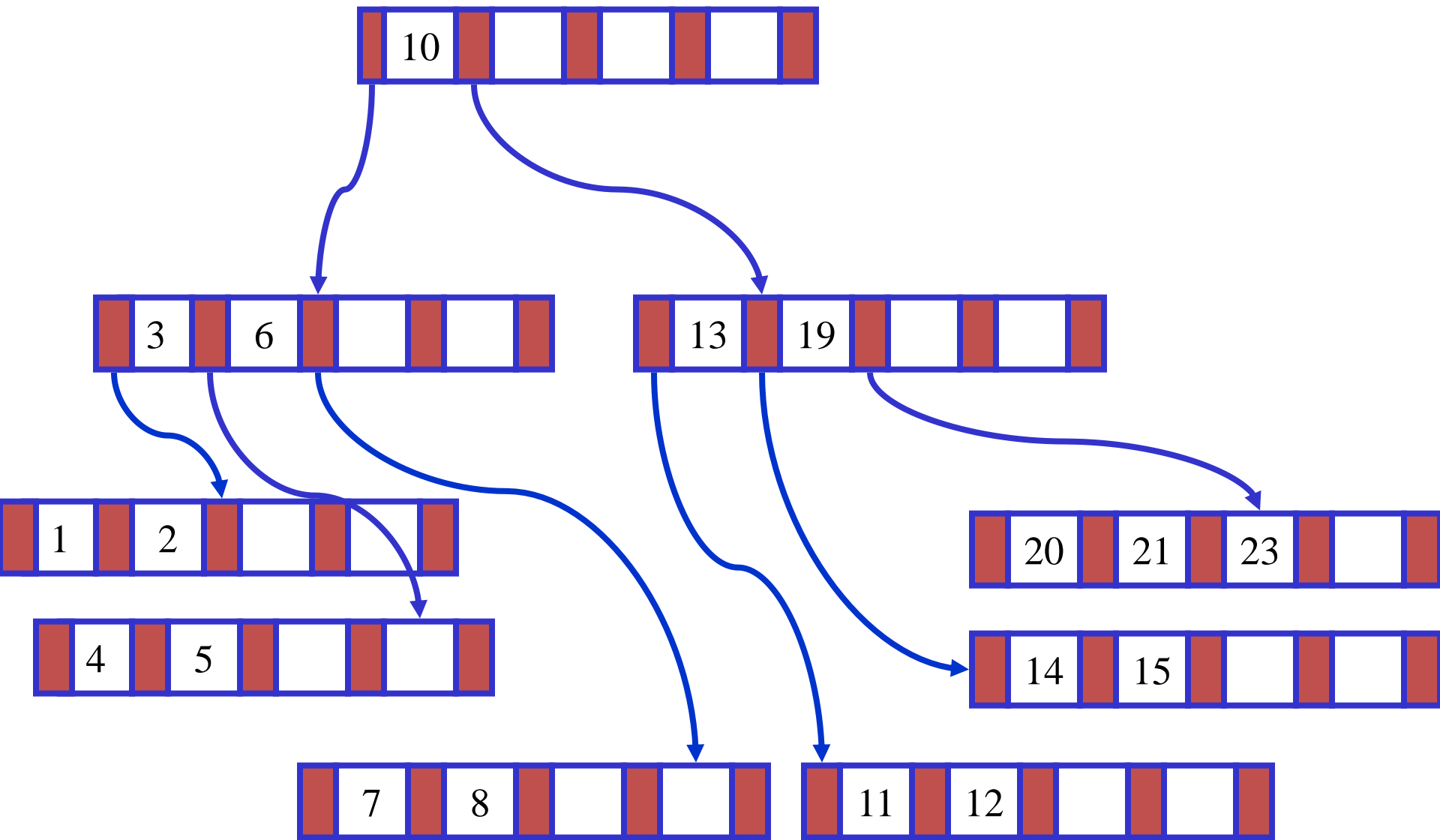

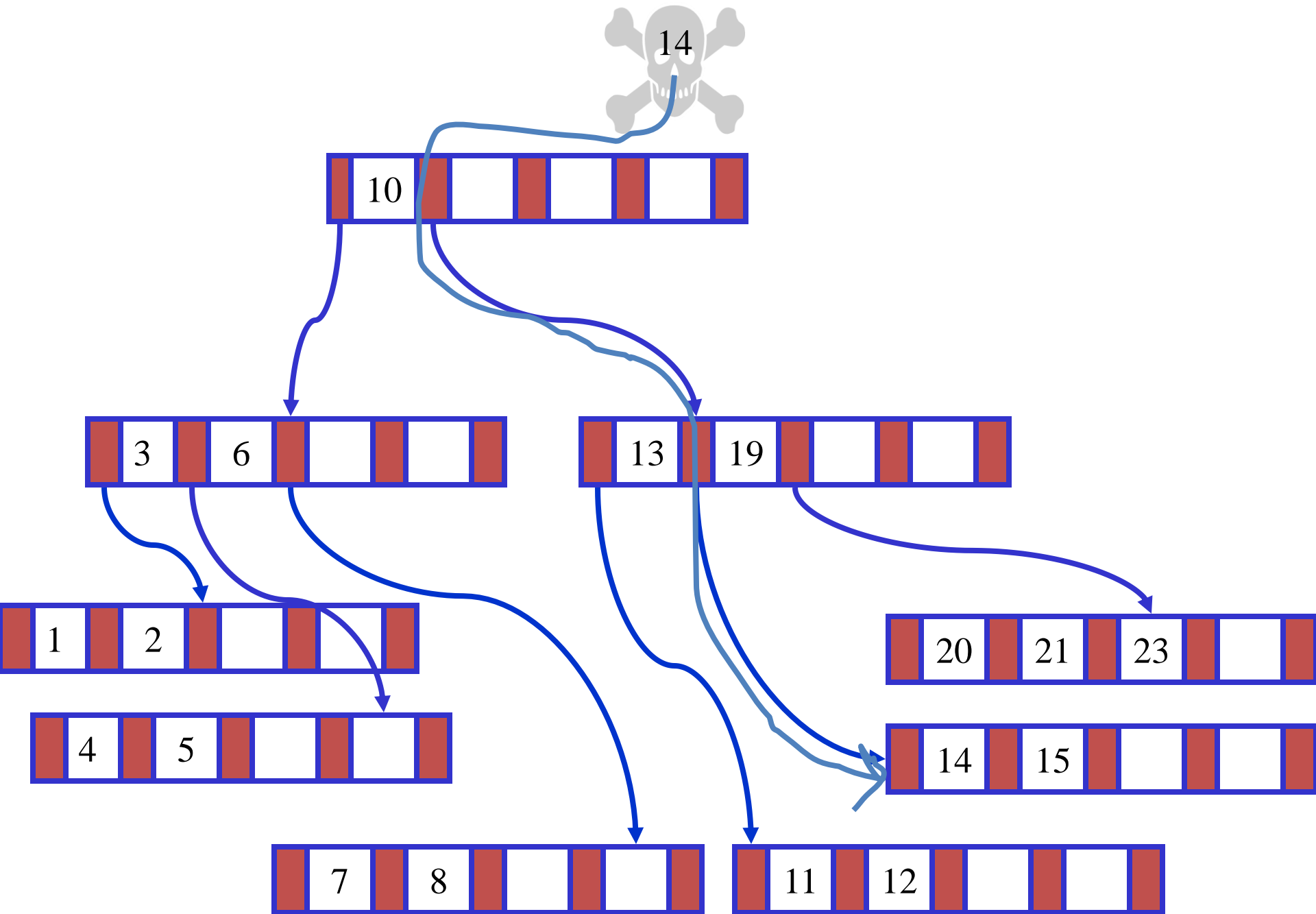



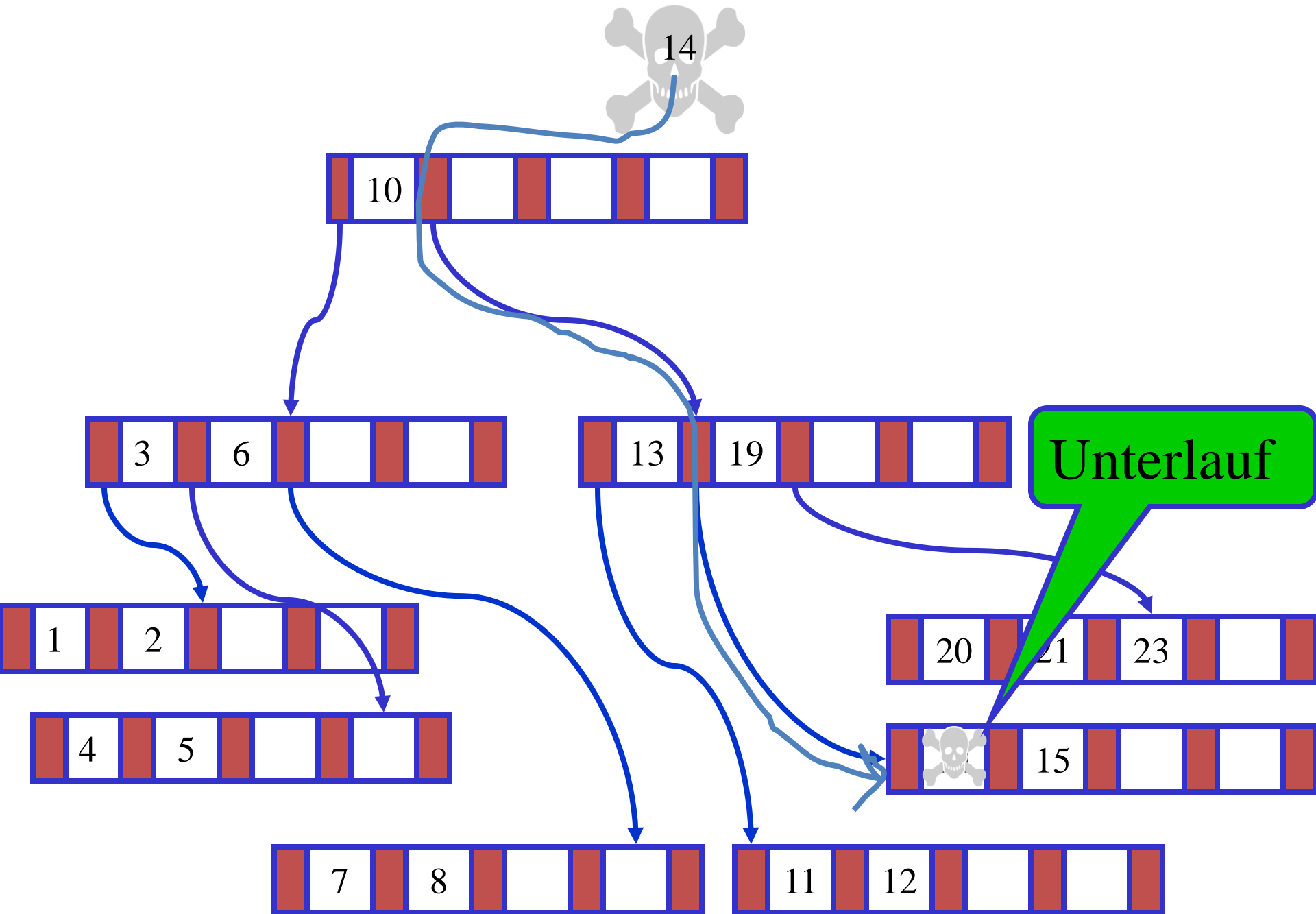

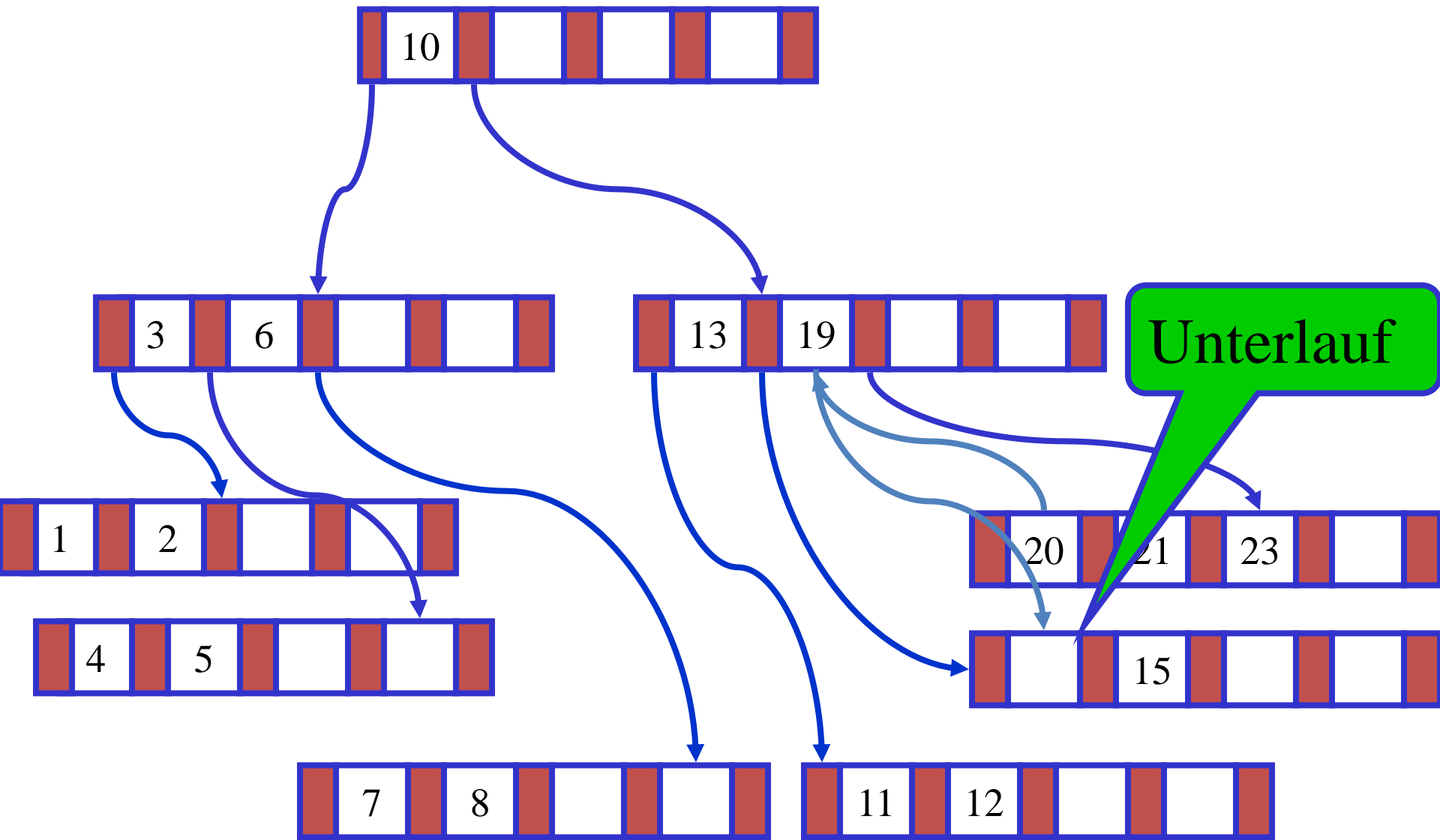

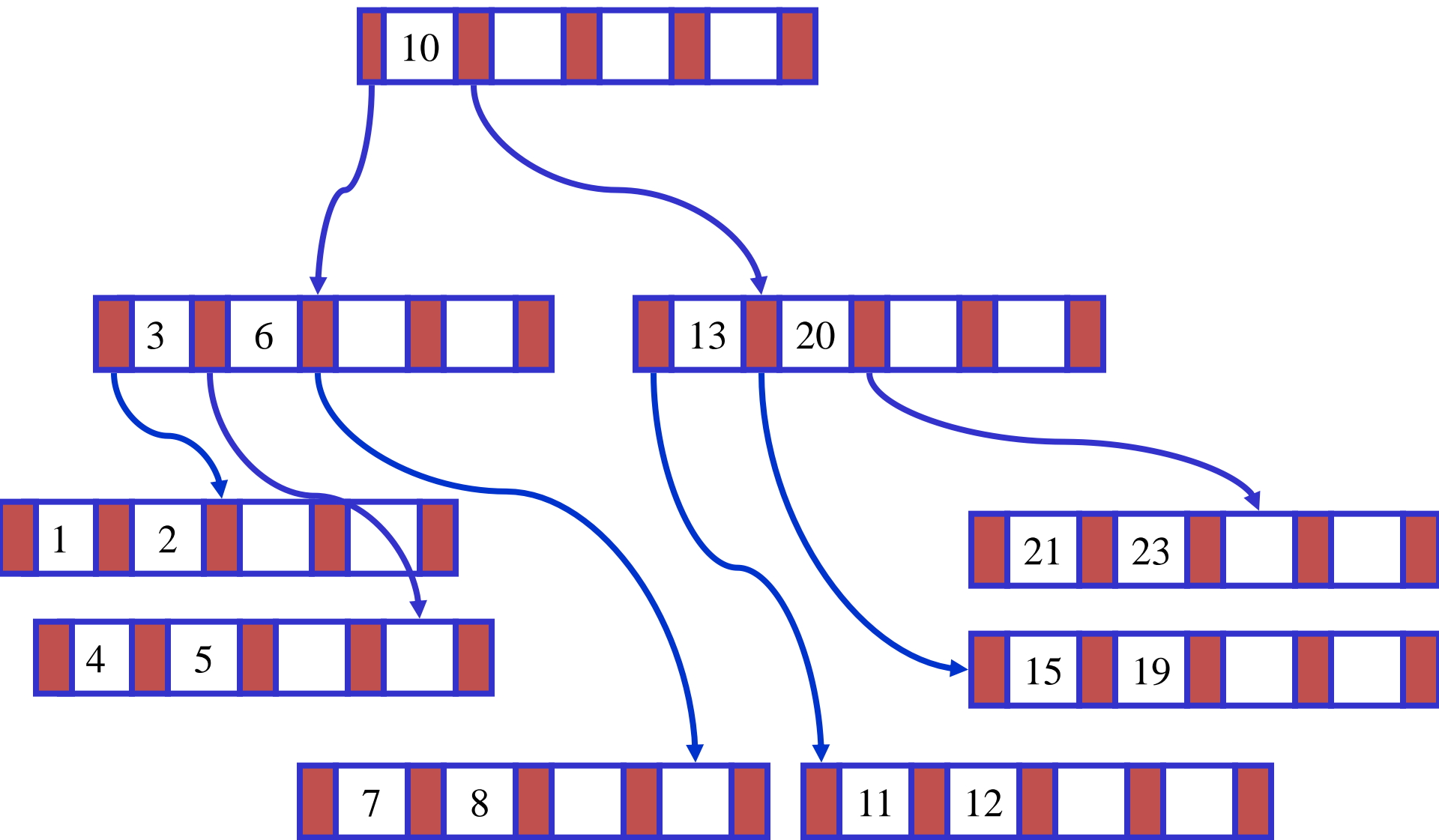

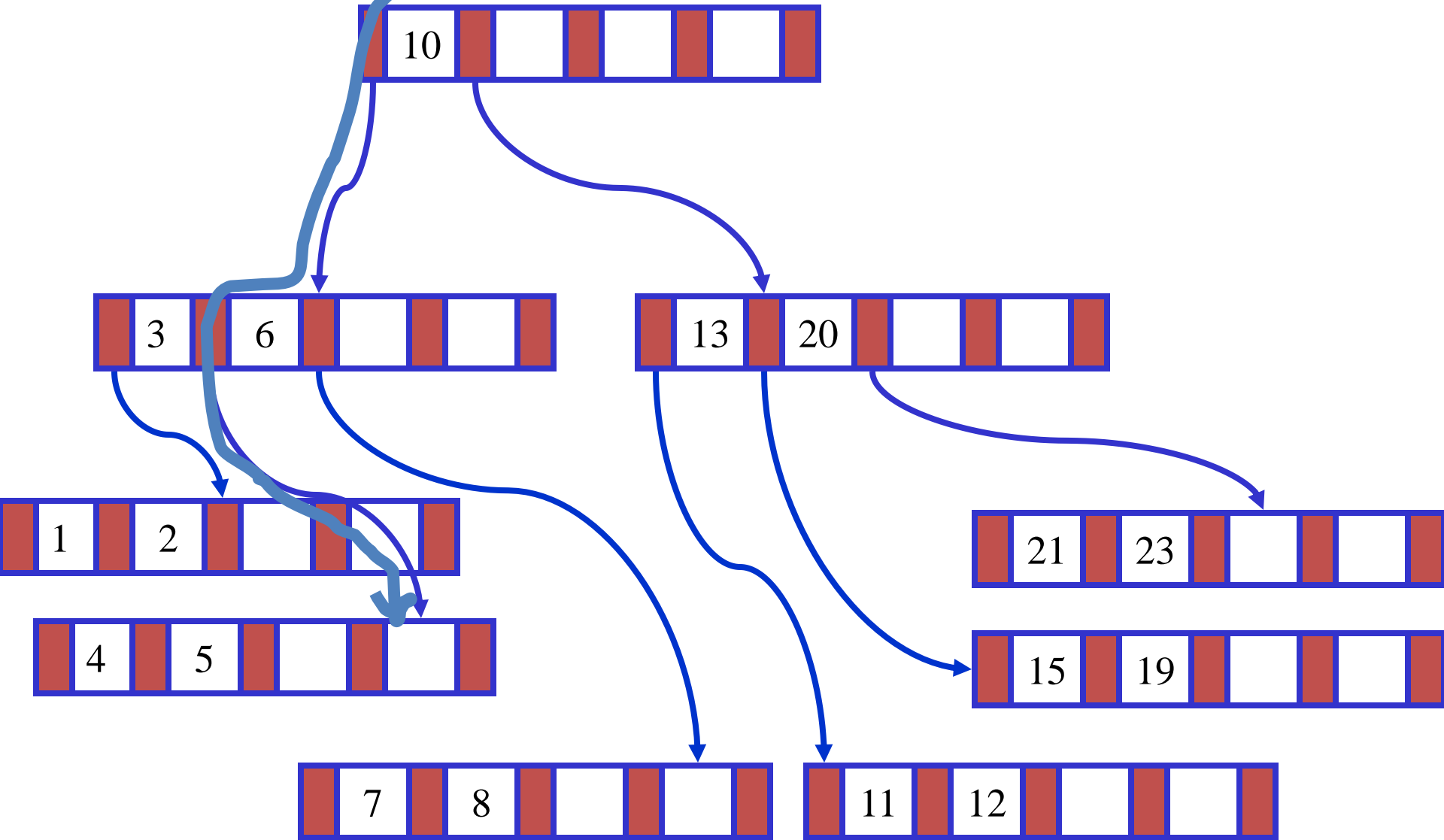

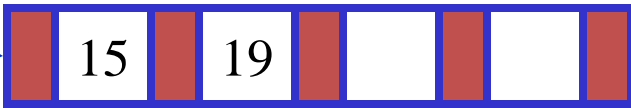
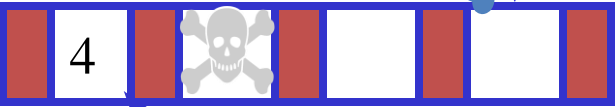
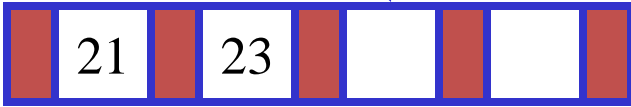
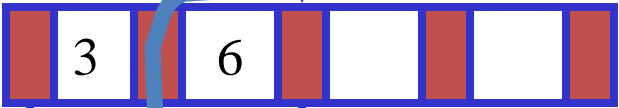
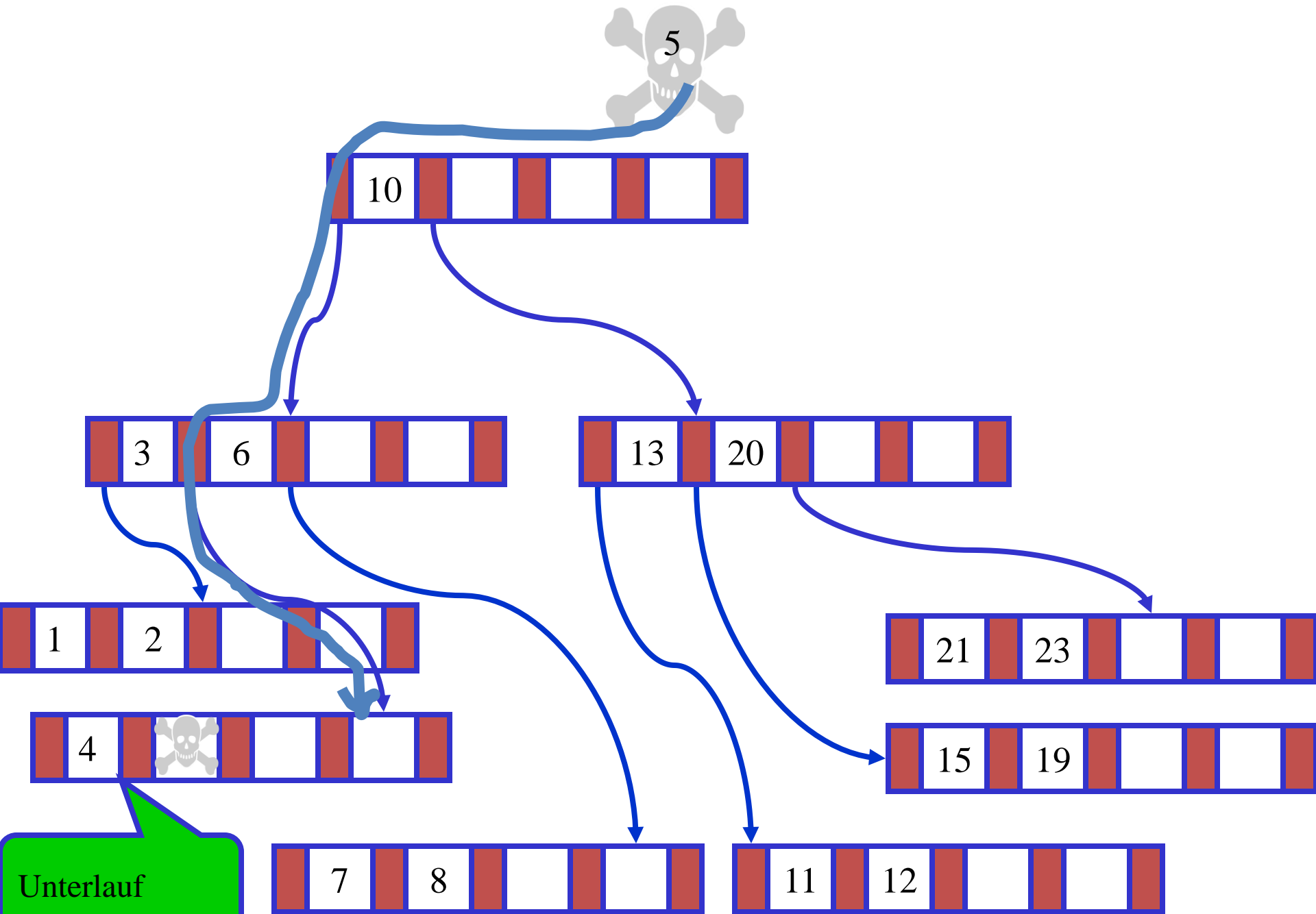

Unterlauf

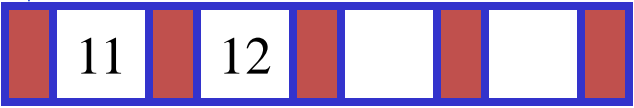
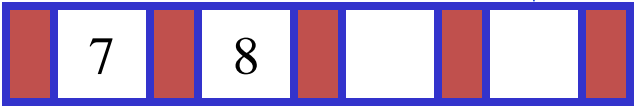

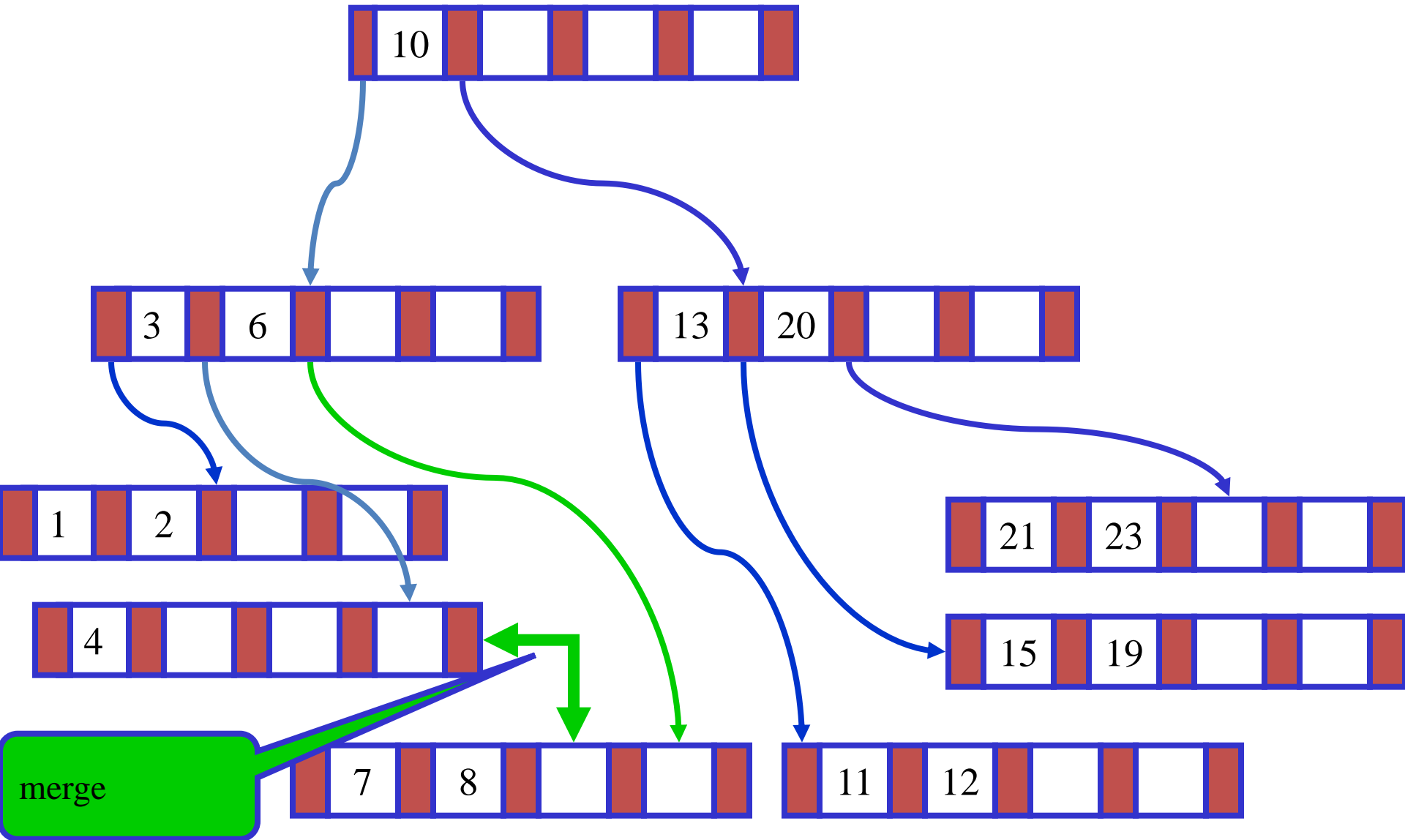

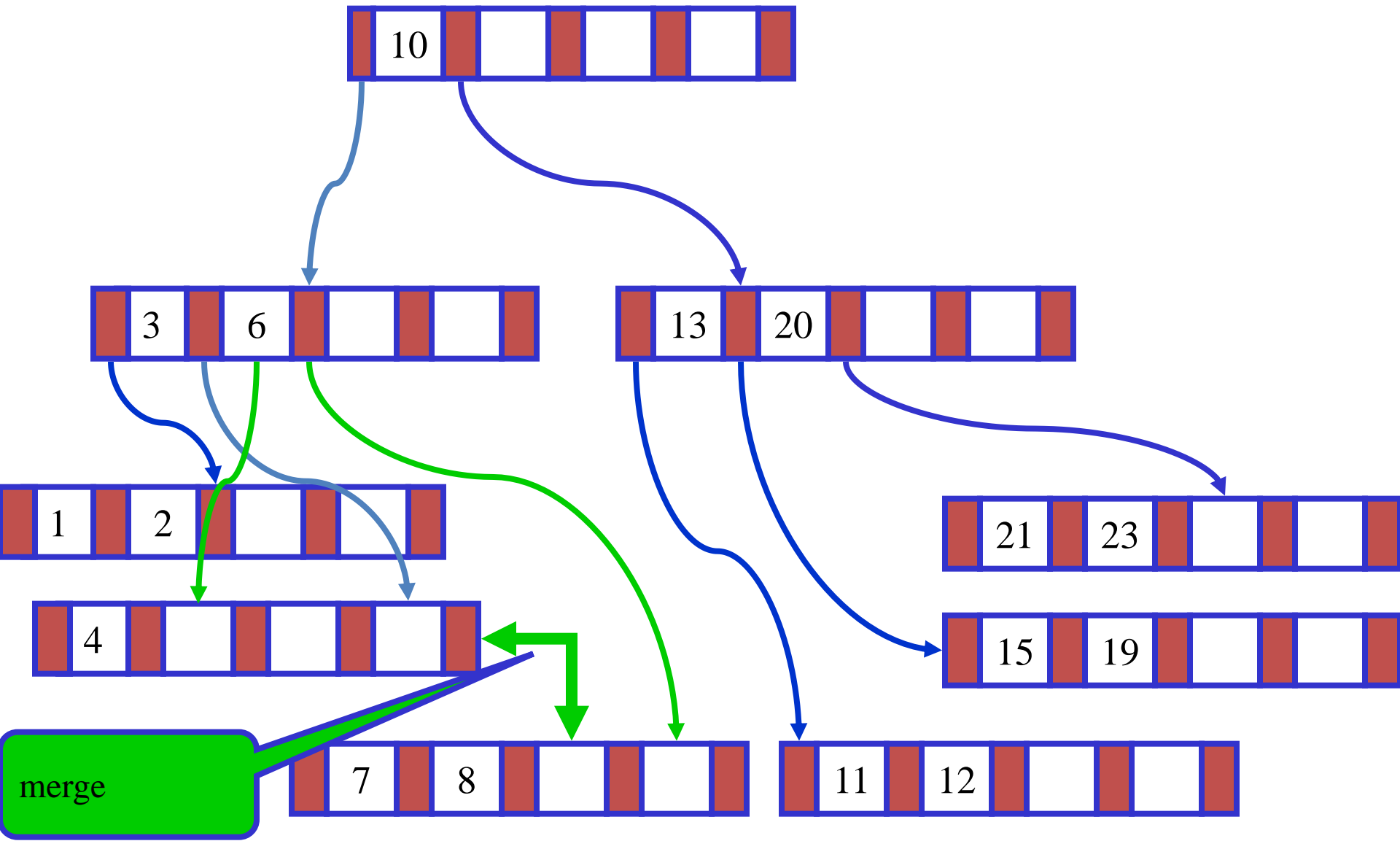

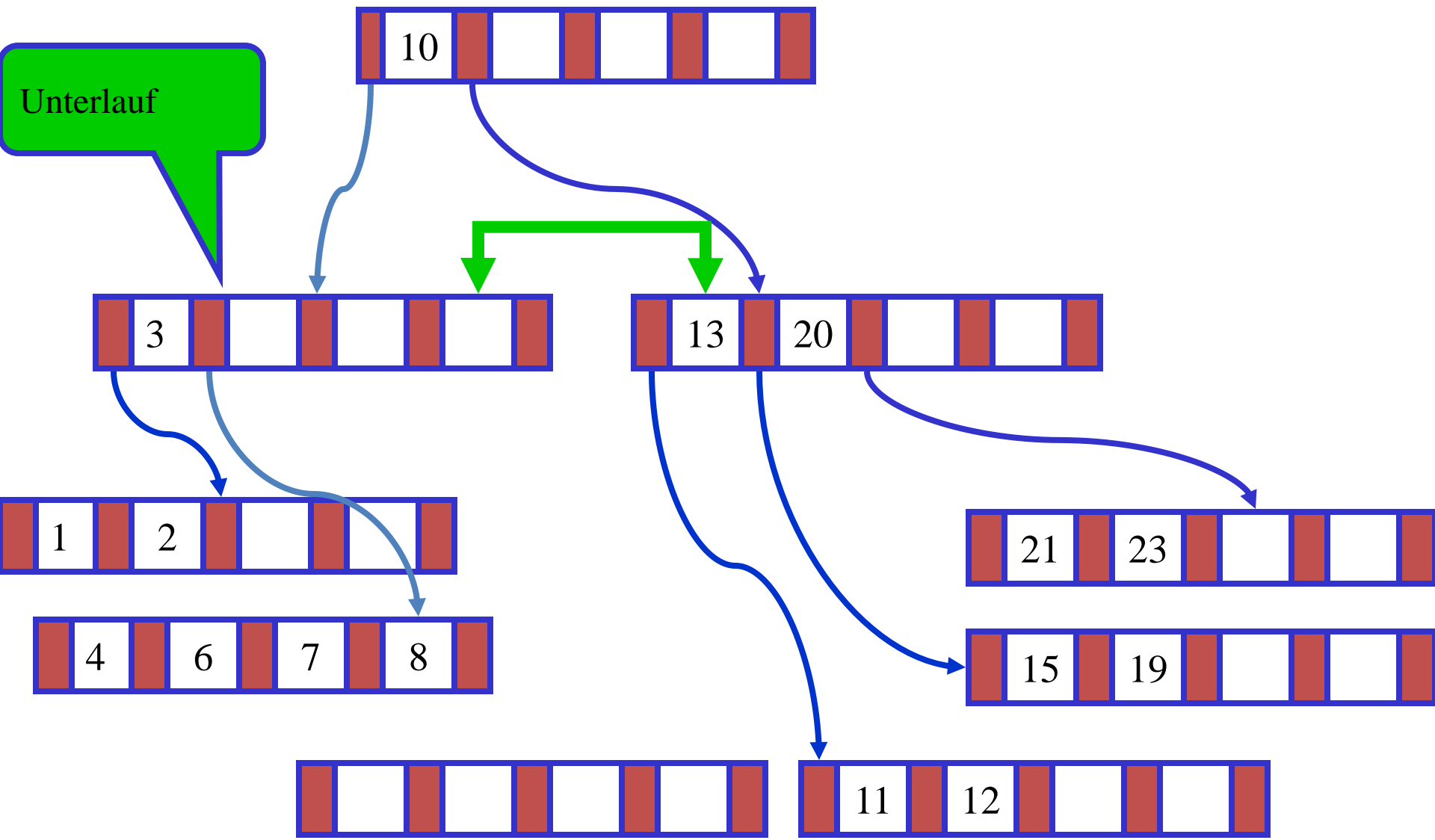



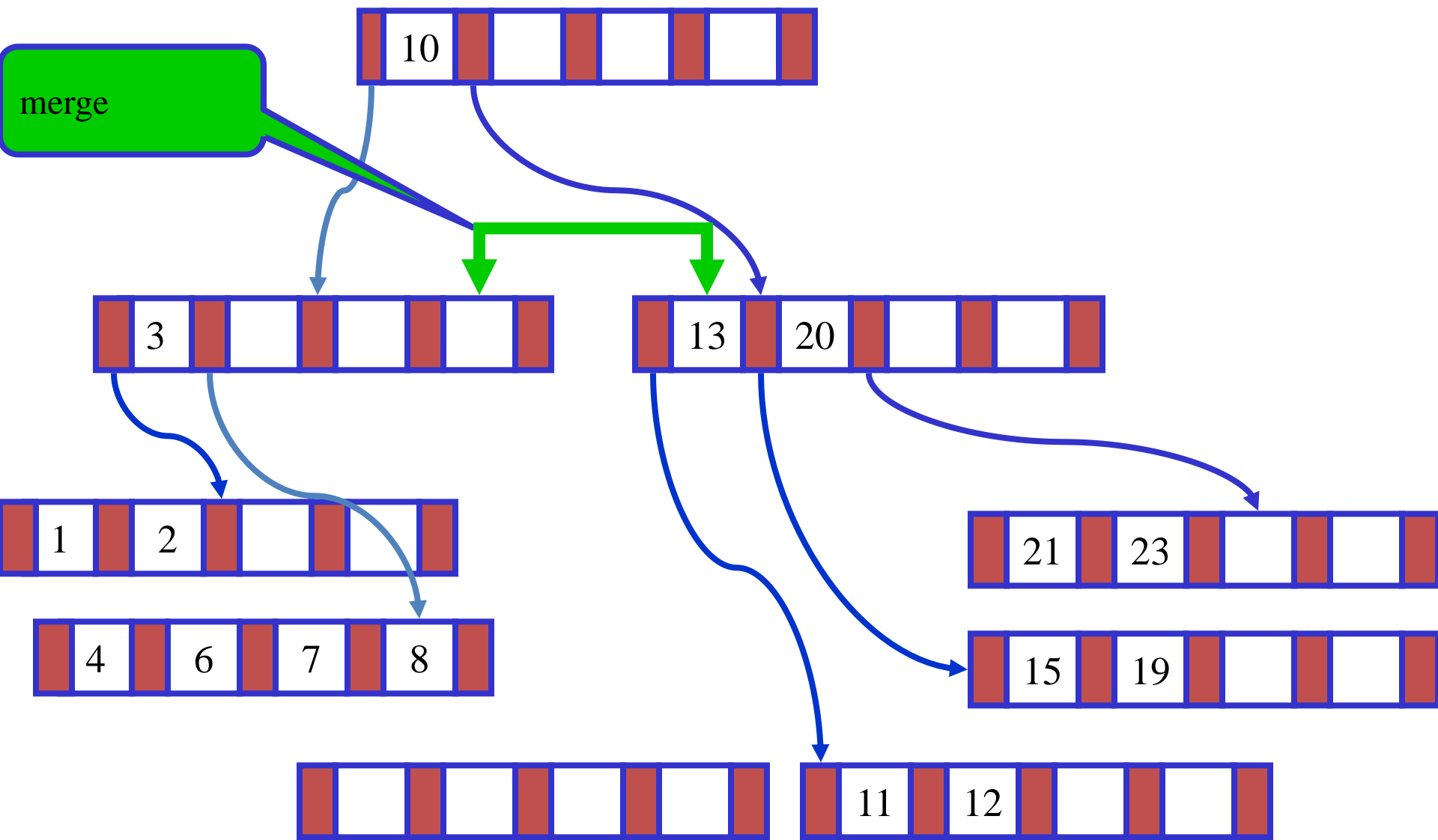

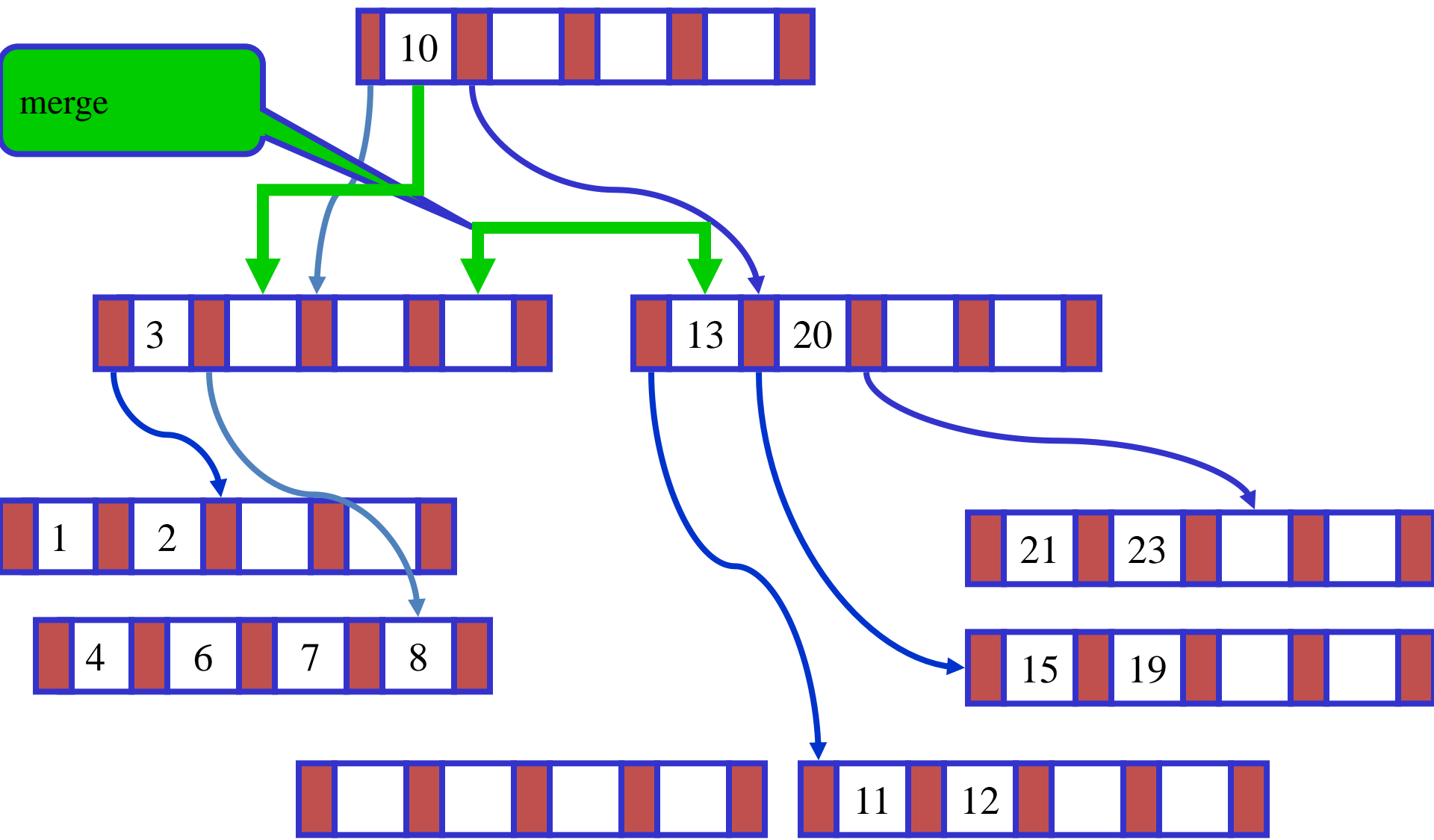

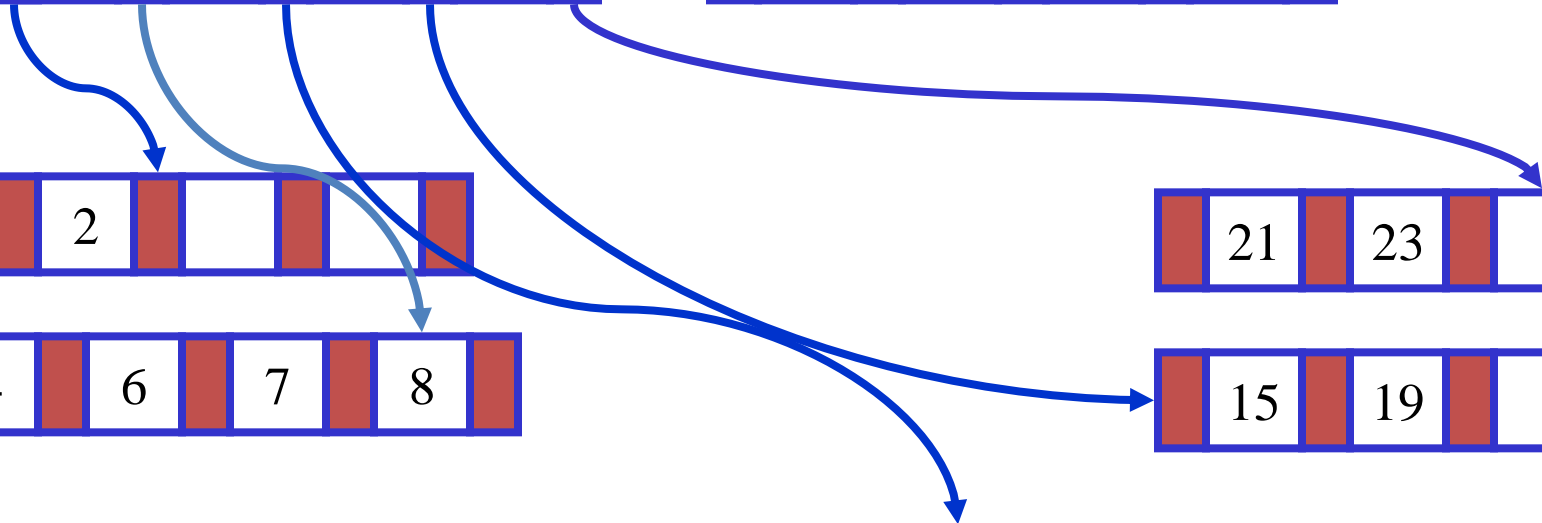
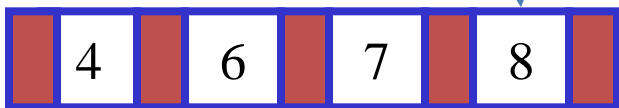
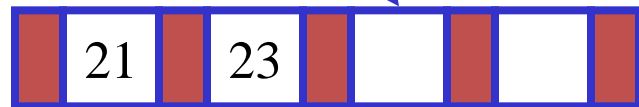
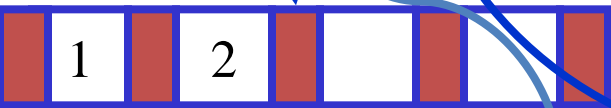
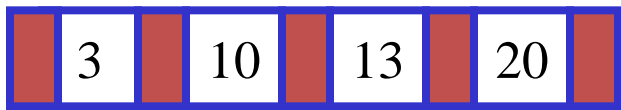

Schrumpfung,  
Freie Knoten

